

**General Certificate of Education
(Advanced Level)
BIOLOGY**

Grade 13

Resource Book

Animal form and function-Part II

Genetics

Department of Science
Faculty of Science & Technology
National Institute of Education
www.nie.lk

G.C.E. (Advanced Level)
Biology
Grade 13
Resource Book
Animal form and function Part II
Genetics

© National Institute of Education
2018

Department of Science
Faculty of Science and Technology
National Institute of Education
www.nie.lk

Message from the Director General

The National Institute of Education takes opportune steps from time to time for the development of quality in education. Preparation of supplementary resource books for respective subjects is one such initiative.

Supplementary resource books have been composed by a team of curriculum developers of the National Institute of Education, subject experts from the national universities and experience teachers from the school system. Because these resource books have been written so that they are in line with the G. C. E. (A/L) new syllabus implemented in 2017, students can broaden their understanding of the subject matter by referring these books while teachers can refer them in order to plan more effective learning teaching activities.

I wish to express my sincere gratitude to the staff members of the National Institute of Education and external subject experts who made their academic contribution to make this material available to you.

Dr. (Mrs.) T. A. R. J. Gunasekara

Director General

National Institute of Education

Maharagama.

Message from the Director

Since 2017, a rationalized curriculum, which is an updated version of the previous curriculum is in effect for the G.C.E. (A/L) in the general education system of Sri Lanka. In this new curriculum cycle, revisions were made in the subject content, mode of delivery and curricular materials of the G.C.E. (A/L) Physics, Chemistry and Biology. Several alterations in the learning teaching sequence were also made. A new Teachers' Guide was introduced in place of the previous Teacher's Instruction Manual. In concurrence to that, certain changes in the learning teaching methodology, evaluation and assessment are expected.

The previous Teachers' Instruction Manual contains a line-up of subject matter expected to be learnt, but the newly introduced Teachers' Guide does not accommodate any subject matter. Yet, it provides learning outcomes, a guideline for teachers to mould the learning events, assessment and evaluation. Thus, the need of a resource book, which simply describes the subject content emerges. This book comes to you as a result of an attempt to fulfil that requirement. When implementing the previous curricula, the use of internationally recognized standard textbooks published in English was imperative for the Advanced Level science subjects. Due to the contradictions of facts related to the subject matter between different textbooks and inclusion of the content beyond the limits of the local curriculum, the usage of those books was not convenient for both teachers and students.

As this book is available in Sinhala, Tamil, and English, the book offers students an opportunity to refer the relevant subject content in their mother tongue as well as in English within the limits of the local curriculum. It also provides both students and teachers a source of reliable information expected by the curriculum instead of various information gathered from the other sources.

This book authored by experienced subject teachers and subject experts from the universities is presented to you followed by the approval of the Academic Affairs Board and the Council of the National Institute of Education. Thus, it can be recommended as a material of high standard.

Dr. A. D. Asoka De Silva

Director

Department of Science

Guidance

Dr. (Mrs.) T. A. R. J. Gunasekara

Director General

National Institute of Education

Supervision

Dr. A. D. Asoka De Silva

Director,

Department of Science

National Institute of Education

Subject Leader

Miss. P. T. M. K. C. Tennakoon

Assistant Lecturer, Dept. of Science

National Institute of Education

Internal Editorial Panel

Mrs. H. M. Mapagunaratna - Senior Lecturer
National Institute of Education

Mr. P. Atchuthan - Assistant Lecturer
National Institute of Education

Mrs. D. A. H. U. Sumanasekara - Assistant Lecturer
National Institute of Education

External writing and editorial panel

Prof. A. Pathirathna - Senior Professor, Department of Zoology and
Environmental Management, University of Kelaniya
(Unit 05)

Dr. S. Kumburegama - Senior Lecturer, Department of Zoology,
University of Peradeniya -(Unit 05)

Dr. G. Galhena - Senior Lecturer, Department of
Zoology, University of Colombo (Unit-06)

Prof. S. Hettiarachchi - Senior Professor, Department of Biological
Sciences, University of Rajarata - (Unit 06)

Prof. B. G. D. N. K. de Silva - Senior Professor of Molecular Biology,
University of Sri Jayawardanepura - (Unit 06)

Prof. S. Rajapaksha - Professor, Department of Molecular Biology and
Biotechnology, University of Peradeniya.(unit 06)

- Mrs. B. Ganeshadas - SLTS-I, D.S.Senanayake College, Colombo 08
- Mrs. H. A. S. G. Perera - SLTS-II-I , Sirimawo Bandaranayake College, Colombo -07
- Mrs. M.S.J. Jayasuriya - SLTS, Ladies College, Colombo 07
- Mrs. C. Ukwatta - SLTS-II-I, D.S. Senanayake Colege, Colombo
- Mrs. V. samaeraweera - SLTS-I, Co/Defence School, Colombo 02.
- Mrs. C. V. S. Devotta - SLTS-I ,Dammissara College, Natthandiya

Language Editing

- Mr. M.A.P. Munasinghe - C.P.O -(Rtd)
National Institute of Education

Diagrams

- Mrs. N. R. D. Dahanayake, Teacher,
Lyceum International School, Nugegoda

Cover & Type setting

- Mrs. R. R. K. Pathirana
Technical Assitant- NIE

Supporting Staff

- Mrs. Padma Weerawardana - NIE
- Mr. Mangala Welipitiya - NIE
- Mr. Ranjith Dayawansa - NIE

Content

Message from the Director General	iii
Message from the Director Science	iv
Team of Resource Persons	v
Unit 05 : Animal Form and Function	
Processes and systems involved in coordination	01
The gross structure and the functions of the human nervous system	04
Human sensory structures and functions	16
Basic Structures and Functions of the Human Skin	28
The role of human endocrine system	30
Maintenance of constant internal environment within limits in the human body	40
Modes of reproduction seen among animals	45
Structure and Function of the Human Male Reproductive System	47
Structure and Function of the Human Female Reproductive System	54
Hormonal control of the human female reproductive cycles	57
Birth Control Methods	66
Modern reproductive technology for resolving infertility problems	68
The structure and functions of the skeletal systems of animals	69
The human skeleton	70
Organization of the human axial skeletal system	72
The structure and functions of the human appendicular skeleton	80
Main types of joints in the human skeletal system	85
Unit 06- Genetics	
Vocabulary in genetics	89
Monohybrid Cross	91
Dihybrid Cross	93
Success of Mendel's experiments	95
Probability laws and Mendelian inheritance	95
The testcross	98
Patterns of inheritance of Mendelian characteristics in humans	101
Non-Mendelian inheritance	104
Polyallelism (Multiple alleles)	106
Population genetics	117
Plant and animal breeding	120

05

Animal Form and Function**Processes and systems involved in coordination**

Coordination between stimuli and responses is needed to maintain constant internal environment inside the body of an organism for existence.

Systems contributing to coordination

Animals unlike plants have two different but related systems for coordination of body function. They are the nervous system and the endocrine system.

Table 5.1: Similarities and differences (in relation to coordination) of the nervous system and endocrine system

Feature	Nervous coordination	Hormonal coordination
Transmission	through neurons	through blood
Nature of transmitter	chemical and electrical	chemical
Response	localized	diffused
Time taken to start the response	fast acting	slower action
Duration of response	short	long

Organization of nervous systems in different animal Phyla

Animals have specialized systems of neurons to sense their surroundings and respond rapidly. In the animal kingdom, cnidarians are the simplest animals having a nervous system. They have a diffuse nerve net which is composed of interconnected individual neurons.

In more complex animals, the nervous systems contain groups of neurons organized into nerves, and often ganglia and a brain. In some platyhelminthes such as Planaria, the nervous system contains a pair of ganglia in the anterior region (brain) and a pair of ventral nerve cords that runs longitudinally. In planarians, the eye spots which are located near the ganglia act as photoreceptors. Annelids and arthropods have a somewhat complicated brains and ventral nerve cords. The ventral nerve cord contains ganglia. They are segmentally arranged. Nervous system

of echinodermates is composed of radial nerves and a nerve ring. Nervous system of the chordates consists of a central nervous system (CNS) and a peripheral nervous system (PNS). The CNS is composed of the brain and the spinal cord. The PNS is composed of nerves and ganglia.

Table 5.2: Different organism phyla and their nervous organization

Phylum	Organization	Example
Cnidaria	Nerve net	Hydra
Platyhelminthes	Brain, longitudinal nerve cords	Planaria
Annelida	Brain, ventral nerve cord, segmental ganglia	Leech
Arthropoda	Brain, Ventral nerve cord, Segmental ganglia	Cockroach
Echinodermata	Nerve ring and radial nerves	Sea star
Chordata	Brain, spinal cord (dorsal nerve cord), nerves and ganglia	Gecko

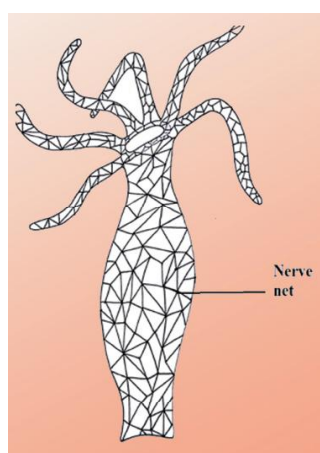

Hydra

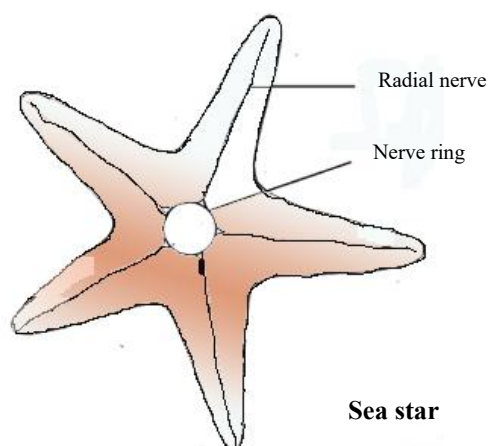

Sea star

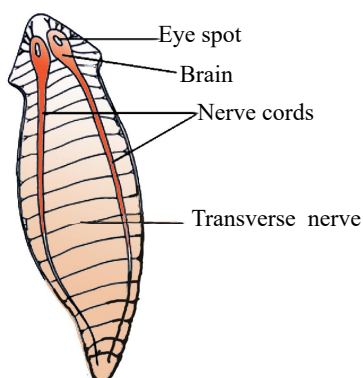

Planaria

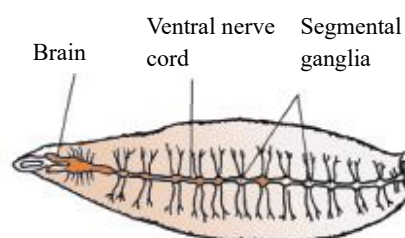

Leech

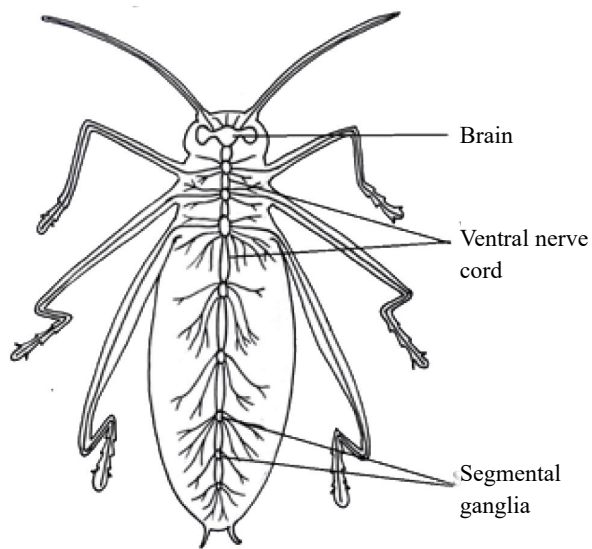

Insect

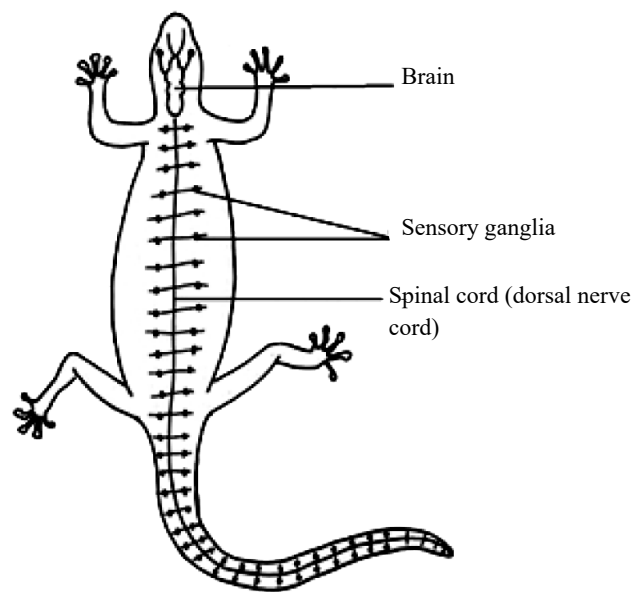

Gecko

Figure 5.1: Organization of nervous systems in different animal phyla

The gross structure and the functions of the human nervous system

Organization and main parts of the human nervous system

Human nervous system consists of central and peripheral nervous systems. In vertebrates, the brain and the spinal cord form the central nervous system. Nerves and ganglia forms the main components of the peripheral nervous system.

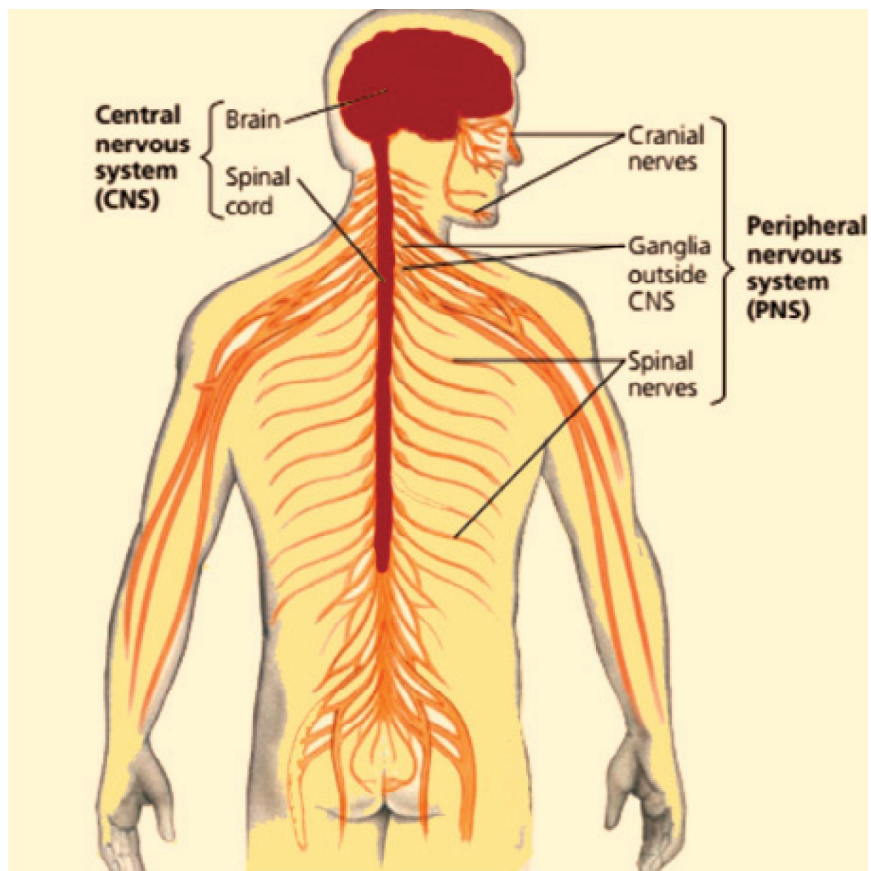
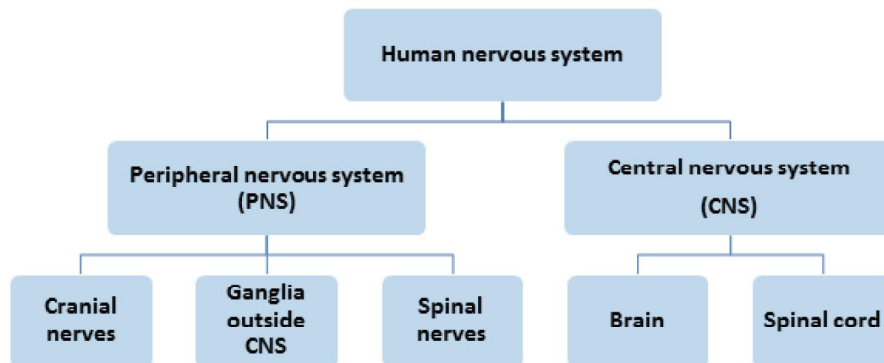

Figure 5.2: The organization of human nervous system

Central nervous system (CNS)

Central nervous system consists of the brain and the spinal cord. In vertebrates, the CNS develops from the hollow dorsal nerve cord during embryonic development. Anterior part of the central nervous system enlarges and forms the brain which has three major regions: forebrain, midbrain and hindbrain. The central canal in the brain forms four irregular shaped cavities called ventricles. The brain contains four ventricles: three ventricles are present in the fore brain and one ventricle is in the hind brain. This central canal continues in the spinal cord. The ventricles and central canal contains cerebrospinal fluid. This fluid helps to maintain uniform pressure within the CNS and act as a shock absorber between the brain and skull. It also helps to circulates nutrients and hormones as well as to remove waste products.

The brain and the spinal cord have several adaptations to be protected from physical injuries. The brain is enclosed by a skull. The spinal cord is surrounded by vertebrae which forms the vertebral column. Further protection to the CNS is given by three layers of tissues called the meninges. The outermost layer is called the dura mater, the innermost layer as pia mater and in between these two layers is the arachnoid mater.

Main parts of the human Brain

The forebrain, midbrain and hindbrain of the human embryo develops into the adult brain. The forebrain gives rise to the cerebrum, thalamus, hypothalamus and pineal body. The mid brain gives rise to part of the brain stem. The hind brain gives rise to cerebellum, pons varoli and medulla oblongata. The brain stem consists of the midbrain, pons Varolii and medulla oblongata.

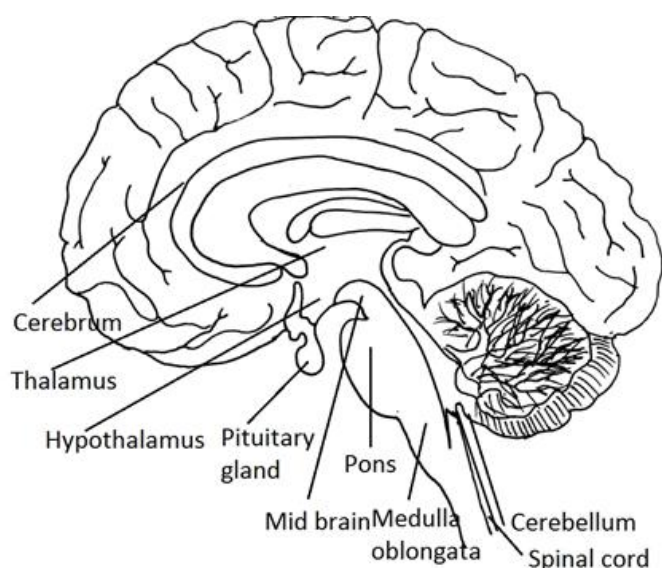

Figure 5.3 : The longitudinal view of the human brain

Cerebrum

Cerebrum is the largest part of the human brain. It is divided by a deep cleft into right and left cerebral hemispheres. The superficial part of the cerebrum is composed of nerve cell bodies (or grey matter) forming the cerebral cortex and deeper layers consist of nerve fibers (or white matter). The two cerebral hemispheres are connected by corpus callosum which is a mass of white matter. The cerebral cortex shows many infoldings to increase the surface area of the cerebrum. The cortex of each cerebral hemisphere is divided into four lobes: frontal lobe, temporal lobe, parietal lobe and occipital lobe.

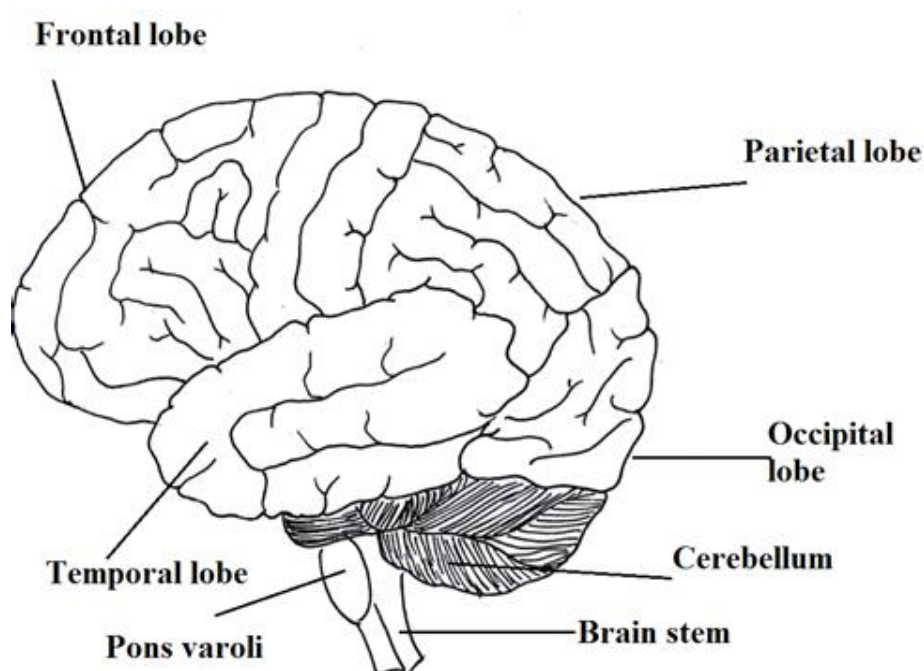

Figure 5.4 : The human cerebral cortex

Three main functional areas of the cerebral cortex have been identified. They are;

- Sensory areas which receive and process sensory information including the perception of pain, temperature, touch, sight, hearing, taste and smell
- Association areas which are responsible for recognition and interpretation of sensory information and integration and processing of complex mental functions such as memory, intelligence, reasoning, judgment and emotions
- Motor areas which are responsible for directing skeletal (voluntary) muscle movement through the initiation and control of voluntary muscle contraction

Thalamus

Thalamus is situated within the cerebral hemispheres just below the corpus callosum. It consists of two masses comprising grey and white matter.

Functions:

Thalamus acts as the main input centre of sensory information from special sense organs and sensory receptors in the skin and integral organ. This sensory information is sorted and directed to specific location of the cerebral cortex for further processing and perception. The thalamus relays and redistributes nerve impulses from most parts of the brain to cerebral cortex.

Hypothalamus

Hypothalamus is situated below and in front of the thalamus, immediately above the pituitary gland. It is linked to the posterior lobe of the pituitary gland by nerve fibers and to the anterior lobe by a complex system of blood vessels.

Functions:

- Regulates body temperature
- Regulates thirst and water balance
- Regulates appetite
- Regulate sleep and wake cycles
- Control of autonomic nervous system
- Initiates fight-or-flight response
- Source for posterior pituitary hormones and releasing hormones that act on anterior pituitary.
- Plays a role in sexual behaviours

Mid brain

Mid brain is the upper part of the brain stem. It is situated between the cerebrum above and the pons below surrounding the cerebrospinal fluid filled connection of the third and fourth ventricles. Mid brain contains aggregates of nerve cell bodies and nerve tracts which connect the cerebrum with lower brain and spinal cord.

Functions:

- Acts as relay stations for ascending and descending nerve fibers
- Receives and integrates sensory information (auditory and visual) and sends it to particular regions of the forebrain, coordinates auditory and visual reflexes

Pons Varolii

Pons Varolii, (a part of the brain stem) is located in front of the cerebellum, below the mid brain and above the medulla oblongata. It contains nerve fibers that form a bridge between the two hemispheres of the cerebellum. It also contain nerve fibers passing between higher levels of brain

and spinal cord. Groups of nerve cell bodies in the pons form centers that regulate respiration. Some nerve cell bodies in the pons act as relay stations.

Functions:

- Transfers information between PNS and the midbrain and forebrain
- Coordinates large scale body movements such as climbing and running
- Together with the medulla oblongata helps regulate respiration.

Medulla oblongata

Medulla oblongata is the lowest part of the brain stem which extends from the pons above and is continuous with the spinal cord below. It consists of cardiovascular centre, respiratory center and reflex centers.

Functions:

- Transfers information between PNS and the mid brain and the fore brain
- Coordinates various body movements such as running, climbing
- Controls several autonomic, homeostatic functions including breathing, heart and blood vessel activities (contains respiratory centre, cardiovascular centre)
- Controls involuntary reflexes such as vomiting, swallowing, coughing, sneezing through reflex centres

Cerebellum

Cerebellum is located behind the pons Varolii and below the posterior portion of the cerebrum. It is also made up of two hemispheres.

Functions

- Coordinates voluntary muscular movements
- Maintains posture and balance
- Helps in learning and remembering motor skills

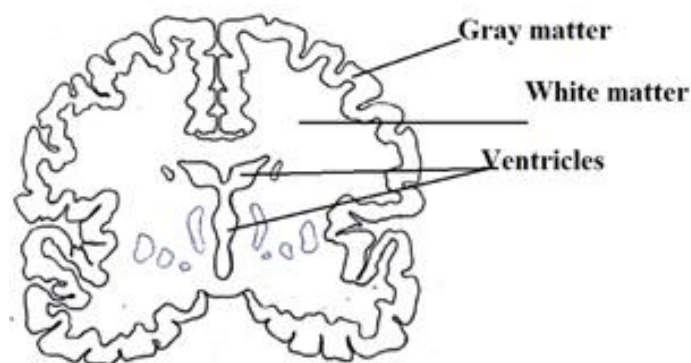

Figure 5.5 : T.S of the human brain

Spinal cord

The spinal cord is an elongated cylindrical structure suspended in the vertebral canal. It is continuous with the medulla oblongata. Centre of the spinal cord contains the central canal which is surrounded by grey matter. Outer region of the spinal cord is made up of white matter.

Functions:

- Links the central nervous systems to sensory and motor neurons and facilitates nerve impulse propagation towards the brain and away the brain
- Coordinates and produces reflexes

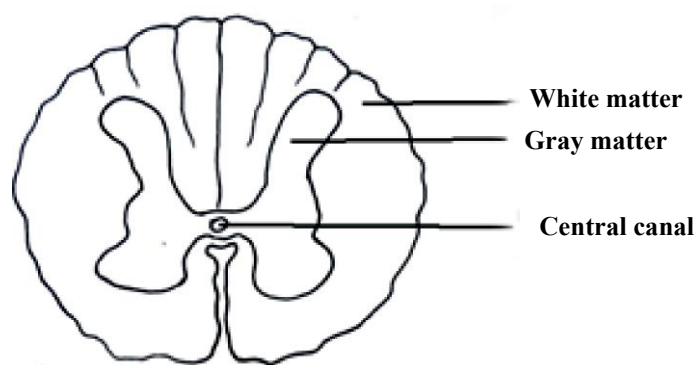

Figure 5.6: T.S of the spinal cord

Peripheral nervous system (PNS)

Peripheral nervous system is made up of cranial nerves, spinal nerves and autonomic nervous system (with ganglia). It transmits impulses to and from CNS regulating both an animal's movement and its internal environment.

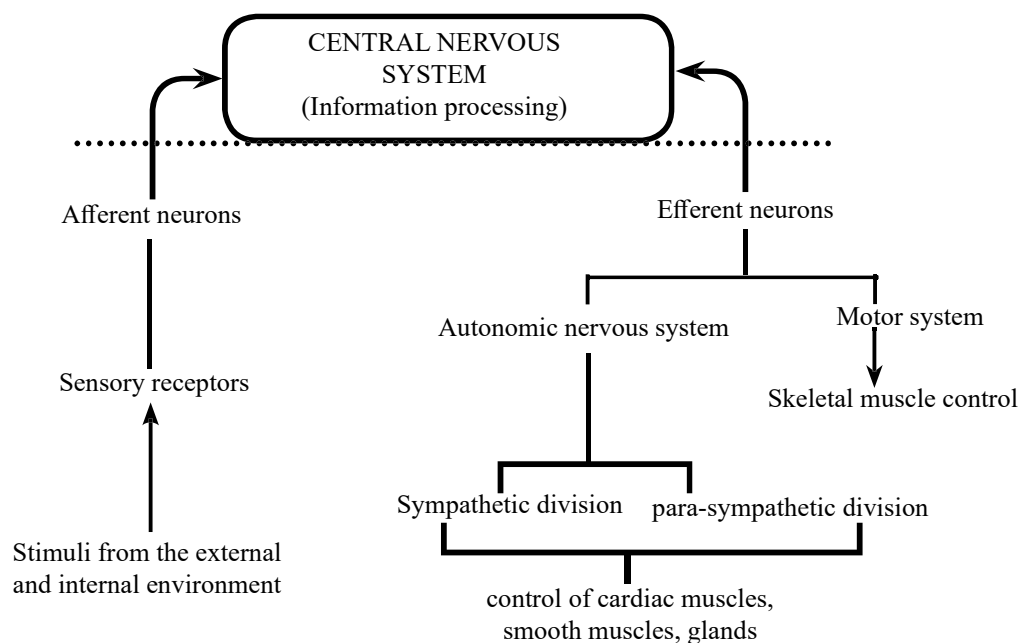

Figure 5.7 : Peripheral nervous system of a vertebrate (Functional hierarchy)

Sensory information from sensory receptors reaches the CNS along PNS neurons referred to as afferent neurons (sensory neurons). Within the CNS this information is processed and instructions are transmitted to effector tissues/organs (muscles, glands and endocrine cells) along PNS neurons referred to as efferent neurons (motor neurons).

PNS consists of two efferent components;

- The motor system- It consists of neurons that carry nerve impulses to skeletal muscles. So it controls voluntary activities.
- Autonomic nervous system- It generally controls the involuntary activities of the body. Autonomic nervous system consists of neurons which carry impulses to control activities of smooth muscles, cardiac muscles and glands.

Autonomic nervous system consists mainly of two divisions:

- Sympathetic division
- Parasympathetic division

Sympathetic and parasympathetic nervous system

The majority of the body organs are supplied by both sympathetic and parasympathetic nerves which have antagonistic (opposite) functions. Sympathetic stimulations prepare the body to deal with exciting/ stressful situations and energy generating situations (fight- or -flight). Parasympathetic division causes opposite responses that promote calming or a return to self-maintenance functions (rest and digest).

The two divisions differ in overall functions, organization and the signal released. Parasympathetic nerves exit the CNS at the base of the brain or the spinal cord as cranial nerves or spinal nerves respectively. On the other hand sympathetic nerves exit only from the spinal cord. Different neurotransmitters enable the two systems to bring about two opposite effects in different organs such as lung, heart, intestine and bladder. For example, when the neurotransmitter secreted by the parasympathetic division is acetylcholine, the sympathetic division secretes norepinephrine.

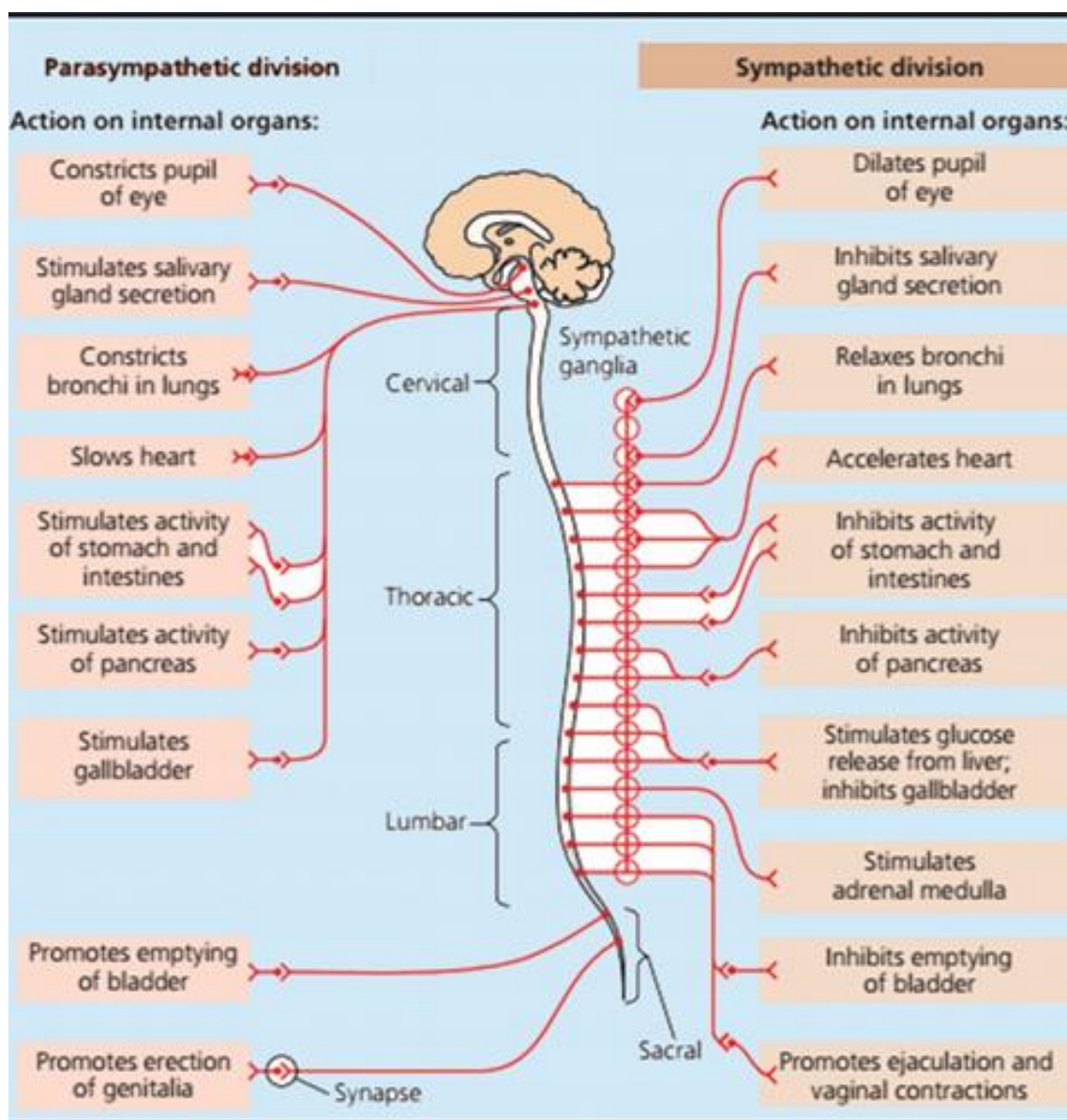

Figure 5.8: The autonomic nervous system (Parasympathetic and sympathetic division)

How nerve impulses are generated and transmitted

In all cells including neurons, ions are distributed unequally between the cell interior and exterior (extra cellular fluid). Generally the inside of the cell is negatively charged whereas the exterior is positively charged. These opposite charges are attracted across the plasma membrane and as a result it creates a voltage difference across the membrane that is referred to as membrane potential.

Resting potential

When a neuron is at rest (when not sending a signal/non conducting), the membrane potential is called the resting potential. In a non-conducting neuron the resting potential is typically between -60 mV and -80 mV.

The resting membrane potential is maintained by;

- Distribution of ion concentrations inside and outside of the neuron- In a non conducting neuron the concentration of K^+ is higher inside the cell while concentration of Na^+ is higher outside. In addition there are Cl^- and other large anions (proteins) inside the cell. As a result a neuron has a negative charge inside the cell and positive charge outside the cell.
- Selective permeability of the plasma membrane to K^+ and Na^+ ions- There are potassium channels and sodium channels, which are membrane bound proteins that are able to open or close in response to stimuli. Potassium channels allows only K^+ ions to pass whereas sodium channels allow only Na^+ to pass. These channels allow K^+ and Na^+ to diffuse according to their concentration gradient. However there are more potassium channels open than sodium channels. As a result there is a net negative charge inside the cell.
- Sodium-potassium pump- This pump helps to maintain Na^+ and K^+ gradient across the membrane by transporting three Na^+ out of the cell for every two K^+ that it transports in. This pump uses ATP to actively transport these ions.

Action potential

An action potential occurs due to a change in membrane potential above a threshold value due to a stimulus. The action potential has the following phases: depolarization, repolarization and hyperpolarization.

Depolarization: A change in the cell's membrane potential such that the inside of the membrane is made less negative relative to the outside. Depolarization results due to Na^+ inflow in response to a stimulus.

Repolarization: Sodium channels close blocking Na^+ inflow. However most potassium channels open permitting K^+ outflow. This makes the inside of the cell negative.

Hyperpolarization: Sodium channels are closed but potassium channels are opened. As a result the inside of the membrane is more negative.

Refractory period

Refractory period is the short time immediately after an action potential in which the neuron cannot respond to another stimulus, owing to the inactivation of sodium channels. This prevents the reverse conduction of an impulse in an axon.

Generation of action potential

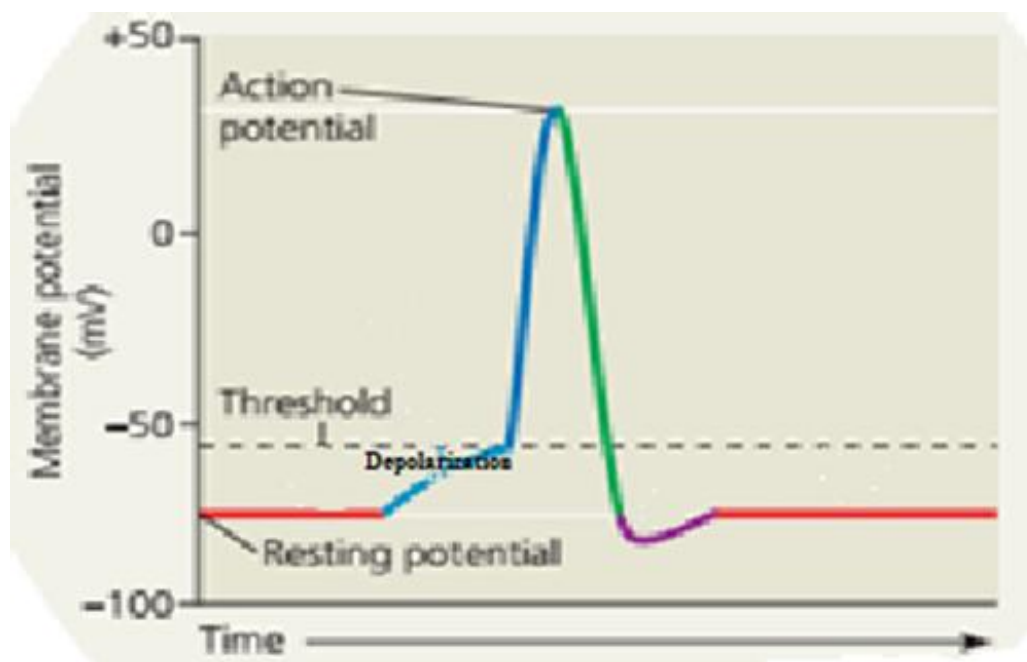

Figure 5.9: Graph of generating action potential

Conduction of action potential (nerve impulse)

- A series of action potentials that move along an axon is defined as a nerve impulse.
- An action potential is generated due to Na^+ inflow (depolarization) at one location in the axon.
- This axon potential spreads to the neighboring location while the initial location repolarizes.
- This depolarization-repolarization process is repeated through the axon.

The speed of conduction depends on:

Diameter of the axon- The conduction speed increases with the increase in axon diameter.

Presence of myelinated axon (in myelinated neuron, axon potential jumps from one node of Ranvier to the next)

Synapses

A synapse is the junction where a neuron (presynaptic cell) communicates with another cell (postsynaptic cell) across a narrow gap (synaptic cleft). Postsynaptic cell may be another neuron, muscle cell or secretory cell. This junction where one neuron communicates with the next cell using a chemical (neurotransmitter) is called a chemical synapse. Some neurons can also communicate through direct electrical connections (electrical synapse).

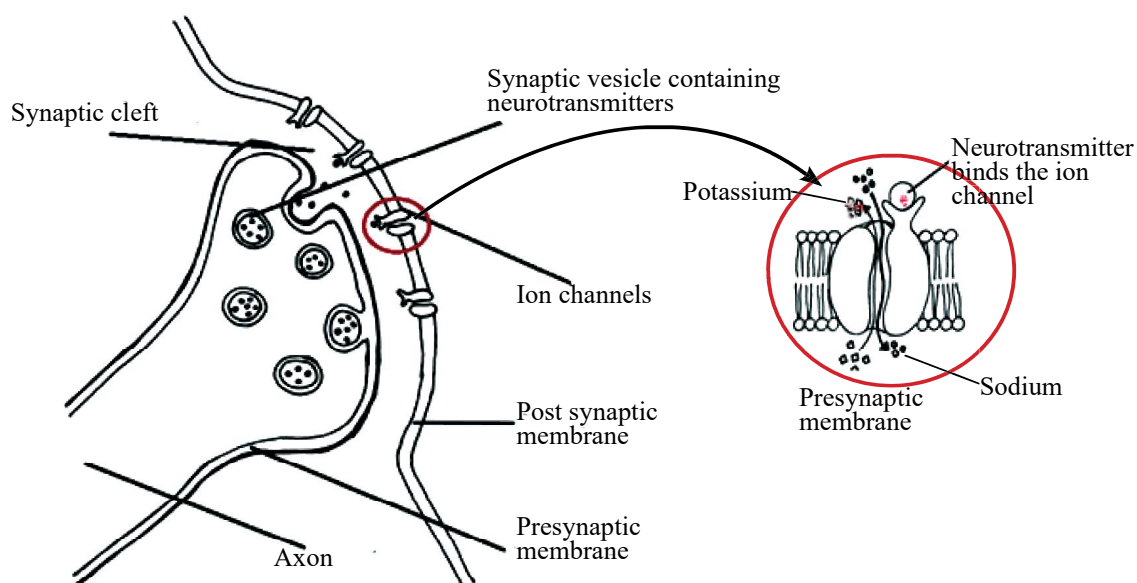

Figure 5.10: A synapse which communicates through a neurotransmitter

Mechanism of transmission of nerve impulses through chemical synapses

- An action potential at an axon terminal depolarizes the plasma membrane of presynaptic cell.
- Depolarization at the presynaptic terminal causes Ca^{2+} to diffuse into the terminals.
- The rise in Ca^{2+} causes binding of synaptic vesicles containing neurotransmitters to the presynaptic membrane.
- This results in the release of the neurotransmitters into the synaptic cleft.
- Neurotransmitters diffuse across the synaptic cleft.
- Neurotransmitters bind and activates specific receptors in the postsynaptic cell membrane.
- If acetylcholine is taken for example, the binding of neurotransmitters to the post synaptic membrane allows Na^+ and K^+ to diffuse across the post synaptic membrane.
- Depolarization takes place in the post synaptic membrane and it reaches the action potential
- After passing the nerve impulse to the postsynaptic cell, the signal is terminated either by:
 - Enzymatic hydrolysis of neurotransmitters
 - Recapture of neurotransmitter into the presynaptic terminals.

Neurotransmitters

Neurotransmitters are the molecules that are released from the synaptic terminals of presynaptic neuron and diffuse across the synaptic cleft, bind to the receptors at the postsynaptic membrane, triggering a response.

Common neurotransmitters are;

- Acetylcholine
- Some amino acids
- Biogenic amines
- Neuropeptides
- Some gases

Reflex arc

Reflex arcs are the functional unit of the vertebrate nervous system. Typically a reflex arc consists of three neurons. They are

1. Afferent/ Sensory neuron
2. Interneuron
3. Efferent/ Motor neuron

A sensory neuron transmits impulses from a sensory receptor to the central nervous system where it synapses with an associated neuron called interneuron. This impulse is transmitted to a motor neuron. The motor neuron conveys the signal to effector tissues/organs.

Common disorders of the nervous system

Common disorders of the nervous system are Schizophrenia, Depression, Alzheimer's disease and Parkinson's disease.

- **Schizophrenia:** This is a severe mental disturbance characterized by psychotic episodes in which patients have a distorted perception of reality. They experience voices that only they can hear. They think that others are plotting to harm them. Evidence suggests that this disorder affects neural pathways that use dopamine as a neurotransmitter.
- **Depression:** Depression is likely to be due to a complex combination of factors that include: Changes in neurotransmitter levels in the brain, genetics, psychological, social, environmental factors. People who are suffering from this disorder show depressed mood, abnormalities in sleep, appetite and energy level. In some conditions once enjoyable activities are no longer pleasurable or interesting. Some conditions involve extreme mood swings. Effective therapies are available to increase activity of some neurotransmitters in the brain
- **Alzheimer's disease:** This is a severe mental deterioration (dementia) characterized by confusion and memory loss. Patients are gradually becoming less able to dress, bathe and feed themselves. They lose their ability to recognize people including their immediate family members. Cause of the disease is due to progressive and irreversible degeneration of neurons in the brain especially in cerebral cortex with deteriorating mental functioning. The disease affects elderly people. Genetic factors may be involved. So far, there is no cure for this disease.

- **Parkinson disease:** This is a progressive motor disorder that leads to lack of control and coordination of muscle movements. The patients show slowness of movements, difficulty in initiating movements, poor balance; fixed muscle tone causing lack of facial expression; speech problems and muscle tremor of extremities: e.g. shaking a hand, fingers in one hand, shaking head. This disease is associated with gradual degeneration of dopamine neurotransmitter releasing neurons in the brain (mid brain, basal ganglia). The disease is common in the elderly people. Genetic factors may be involved. Disease can be treated but not cured.

Human sensory structures and functions

A sensory receptor is a specialized structure which can detect a specific stimulus and convert the stimulus energy to a changing membrane potential to be transmitted to the central nervous system as action potentials for sensory perception and interpretation. Sensory receptor can be a specialized cell or an organ or a subcellular structure that could detect the stimuli. Some sensory cells are specialized neurons. Sensory receptors can inform the central nervous system about the conditions inside and outside the body in order to maintain homeostasis. Specific sensory receptors detect the stimuli that arise in the external environment whereas internal receptors sense the stimuli that arise inside the body.

Basic characteristic of sensory receptors.

- A specialized structure (cell / organ / subcellular structure) designed to receive a specific stimuli.
- Detect the stimulus if the stimulus is at or above threshold level.
- Convert the energy of the stimulus (e.g. light energy, sound energy) into a changing membrane potential to be later transmitted as an action potential.
- Always connected with the nervous system.
- During the conversion of stimulus energy into the action potential, sensory signal can be strengthened which is called amplification.
- If the stimulation is continuous, many receptors show decrease in responsiveness which is called sensory adaptation (For example upon continuous exposure to a strong smell, perception of that smell gradually decreases and stops within few minutes).

Types of sensory receptors

Sensory receptors can be categorized based on the nature of the stimulus they detect. Several types of sensory receptors are found in the human body. They are chemoreceptors, thermoreceptors, photoreceptors, mechanoreceptors and pain receptors.

- **Chemoreceptors**

These are sensory receptors that respond to chemical stimuli. Chemical substances should always be dissolved in water to stimulate sensory cells. Chemoreceptors include taste receptors and olfactory receptors. These receptors mediate the senses of taste and smell. Some chemoreceptors can detect specific chemicals such as CO₂ in the circulating blood.

- **Taste receptors:** Five basic sensations of taste have been described: sweet, sour, bitter, salt and umami (savory taste). Receptor cells for taste are modified epithelial cells organized into taste buds. Taste buds are found in papillae which are small projections of the tongue. A taste bud consists of taste cells, supporting cells and sensory nerve endings. Substances to be tasted should be dissolved in the fluid surrounding the sensory cells and diffuse to receptor cells.

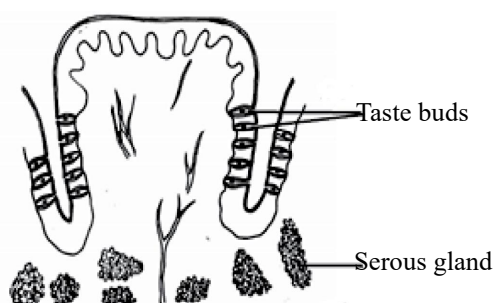

Figure 5.11: A section of a papilla

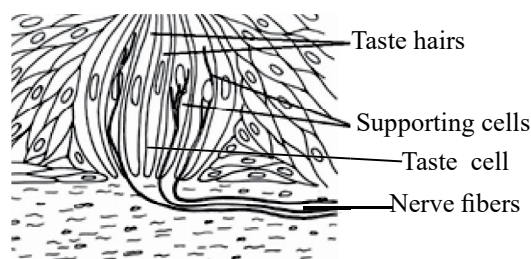

Figure: 5.12-A magnified taste bud

- **Olfactory receptors:** In olfaction, receptor cells are neurons. Olfactory receptor cells are located within the epithelium of the upper portion of the nasal cavity. Receptive ends of the cells extend into the mucus layer of the nasal cavity. When odorants diffuse into this region, receptor cells are stimulated and the nerve impulse is sent along their axons to the olfactory bulb in the brain.
- **Thermoreceptors**

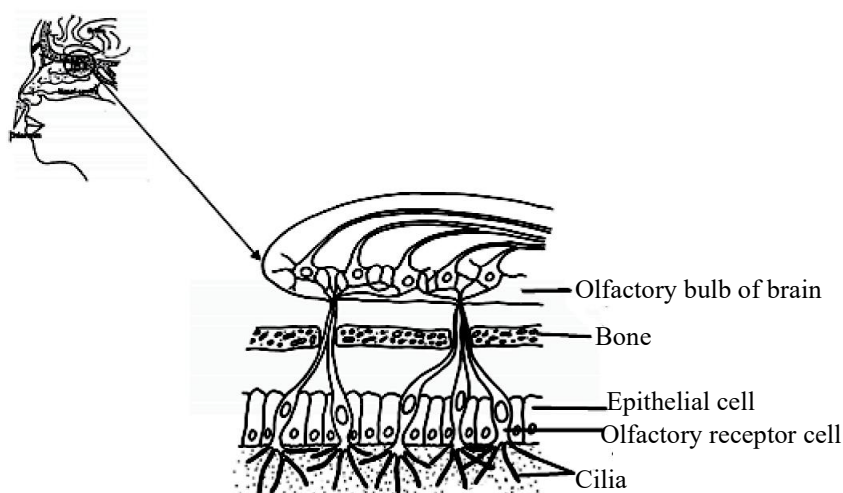

Figure 5.13: Location of olfactory receptors in humans

Thermoreceptors are specialized temperature sensitive receptors which detect heat and cold on the body surface and in the internal environment of the body. Thermoreceptors located in the skin detect the body surface temperature whereas thermoreceptors found in hypothalamus detects the temperature of the blood circulating through the internal organs (core temperature). Thermoreceptors found in the skin are: Krause end bulbs (detect cold), Ruffini corpuscles (detect warmth) and free nerve endings (detect both cold and warmth). Thermoreceptors found in the hypothalamus are specialized neurons.

- **Photoreceptors**

Photoreceptors are sensitive for light. Humans have two main types of photoreceptor cells called rods and cones.

- **Rods:** They are more sensitive to light but do not distinguish colours, they enable us to see at night but only in black and white.
- **Cones:** They provide colour vision. But they contribute very little to night vision as they are not much sensitive. There are three types of cones. Each has a different sensitivity across the visible spectrum providing an optimal response to red, green, or blue light.

- **Mechanoreceptors**

Mechanoreceptors respond to stimuli arising from mechanical energy deformation such as pressure, touch, stretch, motion and sound. Mechanoreceptors in the human body include the following.

- **Touch receptors:** They are mostly present close to the surface of the skin. Examples for touch receptors are Meissner corpuscles (sensitive to light pressure), Merkel discs (sensitive to light touch) and free nerve endings.
- **Pressure receptors:** Example for pressure receptors are Pacinian corpuscles which are present in the deep skin. They are sensitive to deep pressure.
- **Vibration receptors:** Most of the touch receptors can also detect vibrations (e.g. Meissner corpuscles, Pacinian corpuscles). Specific hair cells in the organ of Corti in the inner ear detect sound vibrations. Hair cells of the vestibule of the inner ear detect the gravity whereas hair cells of the semicircular canals detect the motion.

- **Pain receptors**

Pain receptors detect stimuli that reflect harmful conditions that could arise from extreme pressure or temperature and certain chemicals that could damage the tissues. Special nerve endings in different parts of the body can detect the tissue damage. Ultimately the pain is perceived by the brain.

Basic structure and functions of the human eye

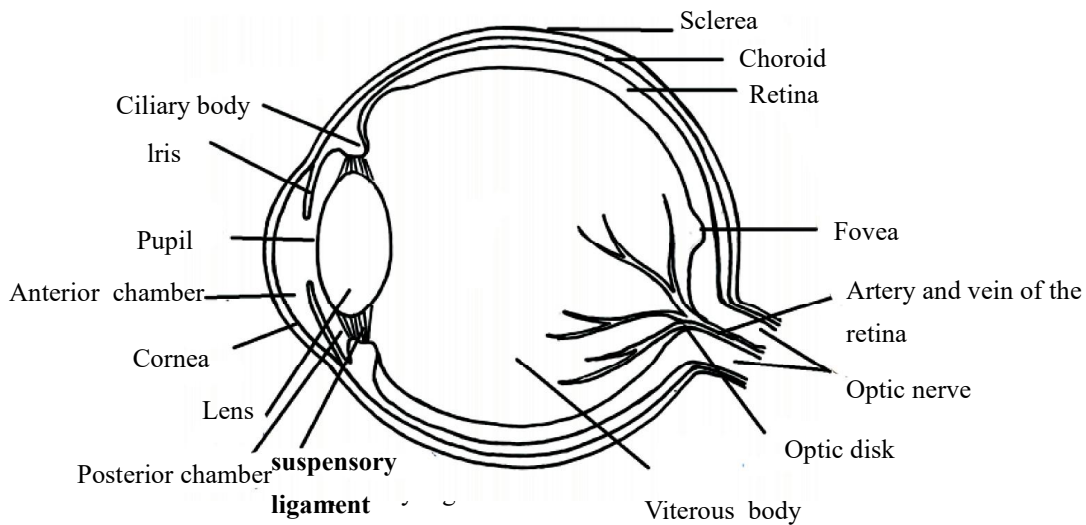

Figure 5.14: The basic structure of the human eye

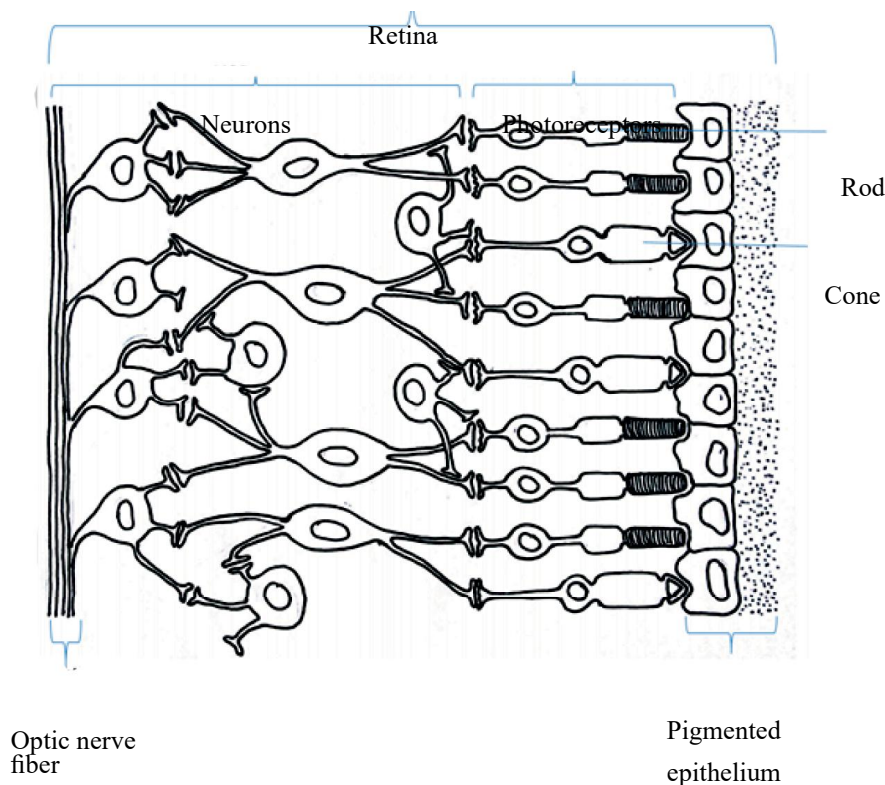

Figure 5.15: The retina

The eye is the organ responsible for sight. There is a fine transparent membrane that lines the iris and front of the eye ball; this is called conjunctiva. The walls of the eye are made up of three layers of tissue: The outer fibrous layer (sclera and cornea), the middle vascular layer (choroid,

ciliary body and iris) and the inner nervous layer (Retina). Inside the eyeball contains the lens, aqueous fluid and vitreous body.

Sclera and cornea

- Sclera is white and opaque. It is the outermost layer of the posterior and lateral aspects of the eye ball. It connects anteriorly with the clear transparent epithelial membrane called cornea. Sclera maintains the shape of the eye and gives attachment of the extrinsic muscles of the eye.
- Cornea is the passage through which light rays reach the retina. It is devoid of blood vessels. The cornea is convex anteriorly and is involved in refracting light rays to focus on the retina.

Choroid, ciliary body and iris

- Choroid is located just beneath the sclera. It is a thin pigmented layer and rich with blood vessels.
- Ciliary body is the anterior continuation of the choroid layer consisting of smooth muscle fibers (ciliary muscle) and sensory epithelial cells. Most of these smooth muscle fibers are circular. Therefore ciliary muscles act as a sphincter. The ciliary body holds the lens in place by suspensory ligaments. The size and thickness of the lens can be controlled by contraction and relaxation of the ciliary muscle fibers attached to these suspensory ligaments. Epithelial cells secrete aqueous humor.
- Iris is a circular coloured body composed of pigment cells. It is located at the front of the eye. It extends anteriorly from the ciliary body and present behind the cornea and in front of the lens. It contains two layers of smooth muscle fibers which are arranged as circular and radial bundles. In the center of iris is a hole called pupil. Iris controls amount of light entering the pupil by changing size which is mediated by the autonomic nervous system. Pigments prevent penetration of excessive light.

Lens

The lens is lying immediately behind the pupil. It is an elastic, biconvex transparent disc made up of protein enclosed within a transparent capsule. It refracts light rays reflected by objects in front of the eye and focuses them on the retina to form the image. By changing the thickness, the lens can vary its refractive power in order to focus rays on the retina.

Aqueous fluid (aqueous humour) and vitreous body (vitreous humour)

In front of the lens, a clear watery substance is present which is called aqueous fluid (Blockage of ducts that drain this fluid can produce glaucoma causing vision loss). Aqueous fluid supplies nutrients and removes wastes from the cornea, lens and lens capsule which have no blood supply. Behind the lens a colourless and transparent jelly like vitreous humour is present. It maintains enough intra ocular pressure to support the retina against choroid and prevents the eye ball from collapsing.

Retina

- Retina is the innermost lining of the eye. It consists of three layers: Outer pigmented epithelium, middle photoreceptive layer and inner layer with neurons. Photoreceptor layer consists of sensory cells (rods and cones) which contain photosensory pigments that can convert light rays into nerve impulses. Retina is thickest at the back. At the centre of the posterior part of the retina, macula lutea (yellow spot) is present. In the center of the yellow spot there is a little depression called the fovea centralis which contains only cones. Towards the anterior part of the retina there are fewer cones than rods. About 0.5 cm to the nasal side of the macula lutea all the nerve fibers of the retina converge to form the optic nerve. The small area of retina where the optic nerve leaves eye is the blind spot (optic disk). It lacks photoreceptors.
- **Photoreceptor cells:** There are two types: rods and cones. Within the outer segment of these cells is a stack of membranous disks in which visual pigments are embedded. In the retina, more rods are present than cones. In the rods visual pigment is rhodopsin. They are sensitive to light but do not distinguish colours. They enable us to see at night but only in black and white. In the cones, visual pigment is photopsin. They provide colour vision. They contribute very little to night vision as they are less sensitive. There are three types of cones each of which has a different sensitivity across the visible spectrum providing an optimal response to red, green or blue light.
- Neurons in the retina: several types of neurons are present including bipolar cells and ganglion cells.

Functioning of the human eyes

Light is reflected into the eye by the objects in the field of vision. In order to achieve clear vision, light reflected from the object within the visual field should be refracted mainly by the lens and focused on the retina of each eye. The processes which are involved in producing a clear image on the retina are refraction of light rays, changing the size of the pupil and accommodation. Then photoreceptor cells in the retina convert light energy to voltage changes leading to action potentials which are sent through the optic nerve to the brain for perception of visual objects. In the retina, stimulation of rods leads to black and white vision. Cones are sensitive to light and colour therefore bright light is needed to activate them and give sharp clear colour, vision. The different wavelengths of visible light activate light sensitive pigments in the cones which result in perception of different colours.

- **Refraction of light rays**

Light rays coming from the visual field pass through the conjunctiva first, then successively through cornea, aqueous fluid, lens and vitreous body before reaching the retina. During this

process light rays are refracted (bent) to focus them on the retina as they all are denser than the air. Lens has changing refractory power while all the other parts (conjunctiva, cornea, aqueous fluid and vitreous body) have constant refractory powers. Light rays are mostly refracted by the biconvex lens.

- **Changing the size of the pupil and accommodation**

For clear vision, the amount of light entering the eye is controlled by changing the size of the pupil which is mediated by the autonomic nervous system. Light rays coming from the distant objects need least refraction but as the object comes closer, the amount of refraction needs to be increased to focus light rays on the retina. Hence for near vision the eye must make some adjustments.

- **Constriction of the pupil:** In bright light, pupils are constricted to avoid entering too much light into the eye and damage the sensitive retina. In dim light, the pupils are dilated to allow entering sufficient light to activate photoreceptors which would eventually enable the vision.
- **Movement of the eye ball (convergence):** As light rays from near objects enter the two eyes at different angles, for clear vision they must stimulate corresponding areas of two retina. Muscles attached to the eye ball rotate the eyes to achieve the convergence. This is under autonomic controls.
- **Changing the refractory power of the lens:** Parasympathetic nervous supply to the ciliary body controls the contraction of ciliary muscles and accommodation of eye. Accommodation is important in near vision for focusing on near objects. In near vision the ciliary muscles contract thereby moving the ciliary body inwards towards lens. As a result convexity of the lens is increased due to the reduction of the pull of the suspensory ligaments on the lens. Thus light waves from the near objects are focused on the retina. When seeing a distant object, ciliary muscles relax, then ciliary body moves away from the lens that increases the pull of the suspensory ligaments on the lens so convexity of the lens is reduced. Thus light rays from distant objects are focused on the retina.

Focusing the image on the retina and converting the light energy to action potential to be transmitted to the brain

- The light waves coming from the object are bent (refracted) and focused on the retina. This process produces an image on the retina which is upside down. Once light rays reach the retina, chemical changes happen in the photoreceptive cells (rods and cones).
- Bipolar cells receive information from photoreceptor cells and each ganglion cell gathers inputs from several bipolar cells. In addition, specific neurons in the retina can integrate information across the retina. Ganglion cells form the optic nerve fibers that transmit sensation from the eyes as action potential to the brain. This change will generate a nerve impulse.
- The optic nerve transmits this nerve impulse into occipital lobes (visual area) of the cerebrum. There the visual objects are perceived in the correct way (the right way up) by the brain.

- Choroid functions in absorption of light after the entered light stimulate sensory receptors in the retina.

Monocular vision and binocular vision in human

In humans, both eyes are located in front of the face which facilitates coordinated vision from the two eyes. However it is possible to see visual fields with one eye. Seeing the visual field using only one eye is called monocular vision. However when one eye is used, three dimensional vision is impaired especially in relation to the judgment of speed and distance.

Seeing the visual field using two eyes with greater overlapping fields of view is called binocular vision. The left eye views more on the left of the visual fields. The right eye views more on the right of the visual fields. Even though each eye views a scene from a slightly different angle, in the middle the visual fields are overlapped. However only one image is perceived due to the fusion of left, middle and right of the visual field images from the two eyes in the occipital lobe of the cerebrum.

Unlike monocular vision, binocular vision enables three dimensional views. So binocular vision is very important in judging the speed and distance of an approaching object such as a vehicle. It gives more accurate assessment of one object relative to another in relation to distance, depth, height and width. In some individuals, binocular vision may be impaired. Such individuals face difficulties to judge the speed and distance of an approaching object.

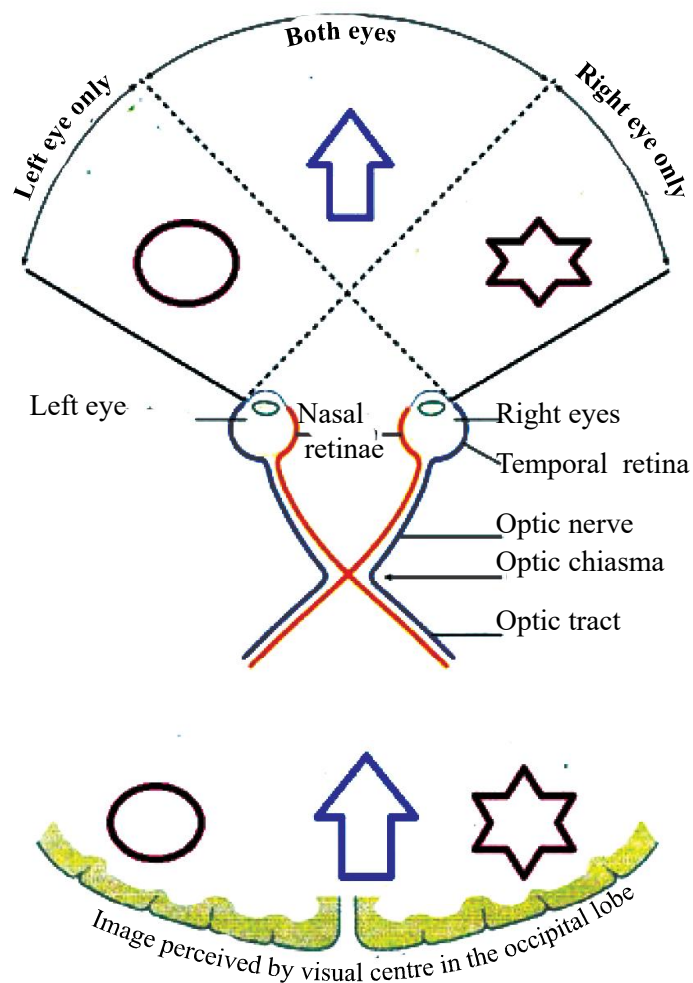

Figure 5.16: Visual fields

Structure of the human ear

Human ear is divided into three parts; outer ear, middle ear and inner ear.

Outer ear consists of pinna and auditory canal. Auditory canal is a slightly “S” shaped tube and lined by hairy skin with numerous modified sweat glands which secrete ear wax. Auditory canal extends to the tympanic membrane which is located in between the middle and the outer ear.

Middle ear (tympanic cavity) is an air filled cavity within the temporal bone. It is lined by simple epithelium. In the medial wall of the middle ear, there are two openings called oval window and round window. Oval window is covered by a small bone called stapes. Round window is covered by a fine fibrous tissue. Three very small bones (ear ossicles) called malleus, incus and stapes extend across the middle ear from tympanic membrane to the oval window. They form movable joints with each other and the medial wall of the cavity at the oval window. Malleus is in contact with the tympanic membrane and form a movable joint with the incus. Incus articulates with the stapes which fits with the oval window. A long tube called Eustachian tube connects the middle ear to the pharynx.

Inner ear is formed from a network of channels and cavities in temporal bone which are called bony labyrinth. Within the bony labyrinth, a network of fluid filled membranes called membranous labyrinth is present which lines and fills the bony labyrinth. Inner ear is composed of three main regions: vestibule, three semicircular canals and cochlea. Vestibule is the expanded part near the middle ear. Oval and round windows are present in its lateral walls. Vestibule contains two membranous sacs called utricle and saccule. Semicircular canals are three tubes arranged at right angles to one another so that one is situated in each of the three planes of space. They are continuous with the vestibule. Cochlea is a coiled structure with the broad base which is continuous with the vestibule. Cochlea has three compartments: an upper vestibular canal, a lower tympanic canal and middle cochlear duct which is a small canal that separates the upper and lower canals. Vestibular canal originates at the oval window and tympanic canal ends at the round window. The two canals are continuous with each other and filled with perilymph. The cochlear duct is a part of the membranous labyrinth and filled with endolymph. The floor of the cochlear duct is called the basilar membrane which bears the organ of Corti (spiral organ). It contains supporting cells and specialized cochlear hair cells containing mechanoreceptors (auditory receptors) of the ear. Hairs of the cochlear hair cells project into the cochlear duct. Many hairs are attached to the tectorial membrane that hangs over the organ of Corti. Auditory receptors are dendrites of sensory nerves that combine to form the auditory nerve to the brain.

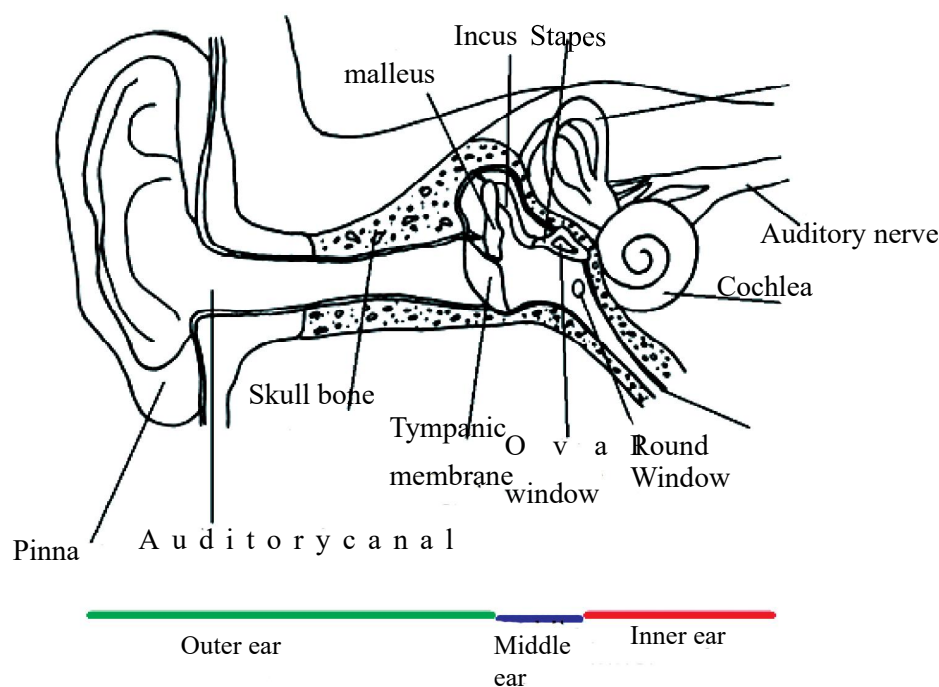

Figure:5.17-The typical structure of the human ear

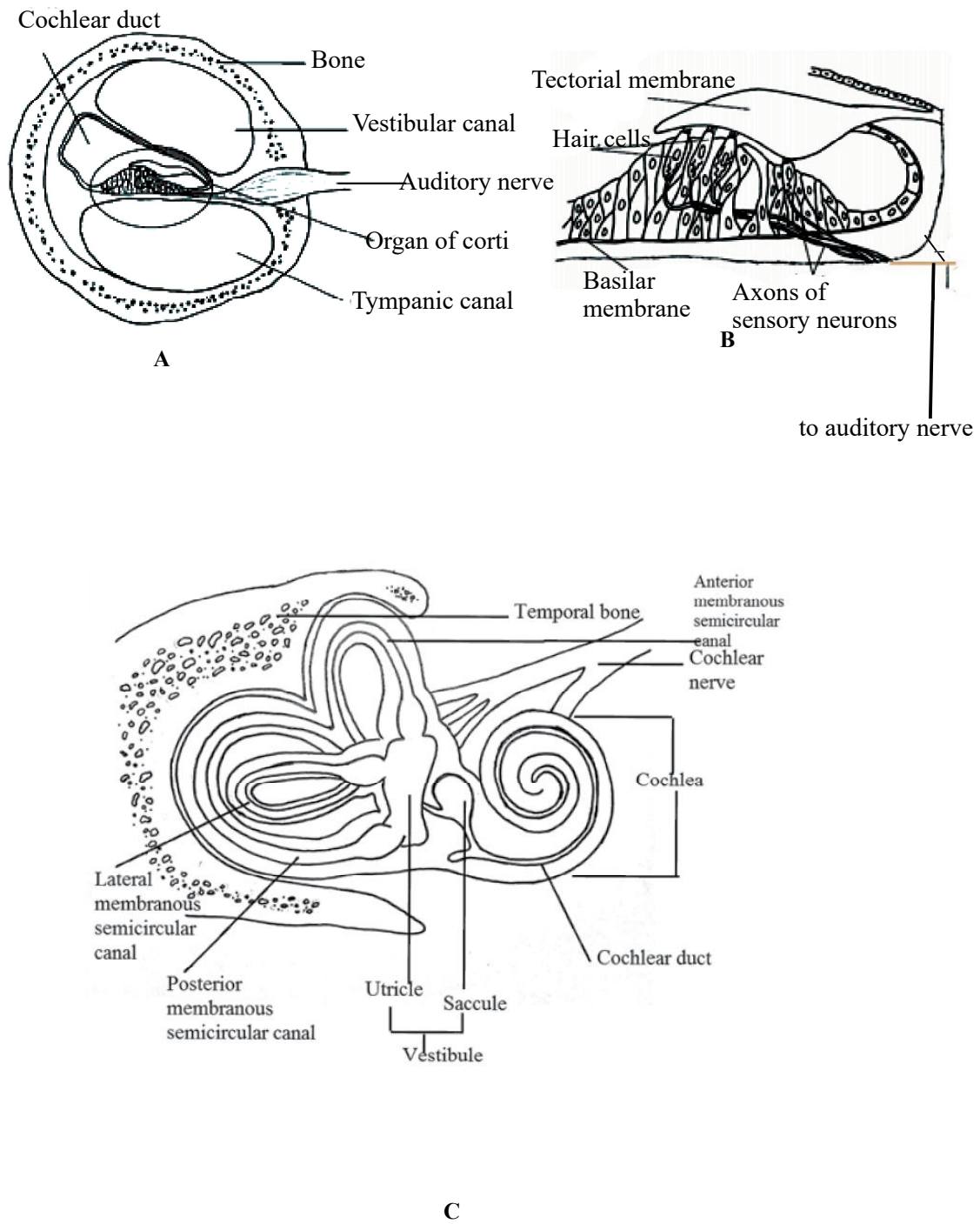

Figure 5.18: (a) . The Cochlea (b) . The organ of Corti (c) The semicircular canals

Functions of the human ear

Hearing

Vibrating objects produce pressure waves in the surrounding air. In hearing, the ear transduces these pressure waves (mechanical stimulus) into nerve impulses that are transmitted to the brain which perceives as sound.

The outer ear collects and concentrates the sound waves and directs them along the auditory canal towards the tympanic membrane. This causes the tympanic membrane to vibrate. Tympanic membrane vibrations are transmitted and amplified through the middle ear by the movement of three jointed ear ossicles.

The ear ossicles transmit the vibrations to the oval window which is located on the membrane of the cochlear surface. When the stapes vibrates against the oval window, pressure waves are created in the perilymph inside the cochlea. When the fluid pressure waves enter the vestibular canal they push down on the cochlea duct and the basilar membrane. As a result, the basilar membrane and attached hair cells vibrate up and down. This causes bending of hair projecting from the hair cell against the fixed tectorial membrane which lies above the hair cells. This results in the stimulation of auditory receptors in the auditory hair cells and generation of nerve impulses. These nerve impulses are passed to the auditory area of the brain (temporal lobe of the cerebrum) for sound perception.

After the sound perception, the fluid wave is finally dissipated into the middle ear by vibration of the membrane of the round window. Eustachian tube maintains the air pressure on both sides of tympanic membrane at the atmospheric pressure level.

Equilibrium

Semicircular canals and vestibule located in the inner ear provide information about the position of the head in space and contribute to maintain the posture and balance.

Utricle and saccule of the vestibule perceive position with respect to gravity or linear movements. Each of these perilymph filled chambers contain hair cells that project into a gelatinous material in which small calcium carbonate particles (otolith) are embedded. When the head is tilted otoliths press on the hairs projecting into the gels. Hair cell receptors transform this deflection into an electrical signal and pass into cerebellum.

The semicircular canals, arranged in three spatial planes detect angular movements of the head. Within each canal, hair cells form a cluster with the hairs projecting into a gelatinous cap. Changes in the position of the head causes movements in the perilymph and endolymph. As a result hair cells are stimulated and resulting nerve impulses are transmitted to the brain.

Basic structures and functions of the human skin

In the human body skin is the largest organ. It consists of two main layers which are the epidermis and the dermis. The layer underneath the skin is called subcutaneous layer which is composed of adipose tissue and areolar tissue.

Epidermis

Epidermis is the outermost layer of the skin which consists of stratified keratinized squamous epithelium. Epidermis is not supplied with blood vessels. But its deeper layers are provided with nutrients and oxygen by the interstitial fluid of the dermis finally drained away as lymph. There are several layers of cells in the epidermis. The deepest layer is the germinative layer from which epidermal cells are originated constantly. These cells undergo gradual changes as they progress towards the surface of the skin. The cells on the surface are flat, thin, non-nucleated and dead, in which the cytoplasm has been replaced by keratin which is a fibrous protein. The surface cells are constantly rubbed off and replaced by the cells underneath. In areas where the skin is subjected to wear and tear, the epidermis is thicker (e.g. palms and fingers of the hand, sole of the foot) Melanocytes in the deep germinative layer secretes a dark pigment called melanin contribute to the skin colour. In addition extent of oxygen saturation in the circulating blood in the dermis, excessive levels of bile pigments and carotenes in the fat layer can affect the skin colour.

Dermis

Dermis is composed of areolar connective tissue. The matrix contains collagen fibers interlaced with elastic fibers. Collagen fibers bind water and give the skin its tensile strength. Fibroblasts, macrophages and mast cells are the main cells found in the dermis.

The structures present in dermis are

- blood and lymph vessels
- sensory nerve endings
- sweat glands
- sebaceous glands
- hair, arrector pili muscles
- sensory receptors (Meissner's corpuscle, Pacinian corpuscle, free nerve endings, bulb of Krause, organ of Ruffini, Merkle discs)

Functions of the human skin

- **Protection:** skin act as a defensive barrier against invasion by microorganisms, entrance of chemicals and physical agents and dehydration. The skin contains keratinized epithelium which is relatively water proof . This layer can protect deeper and more delicate structures. The skin contains specific immune cells which can phagocytose foreign invasions. The melanin pigments protect against the harmful effects of UV radiations.

- **Regulation of the body temperature:** The skin contributes to regulation body temperature as it provides passage through which heat can be lost or gained depending on the body requirements. When body temperature is increased above the normal range, sweat glands secrete sweats onto the skin surface. Evaporation of sweat cools the body surface. When heat stressed, heat loss can be promoted by increasing the blood flow through the skin capillaries by dilating arterioles. When the body temperature falls beyond the normal range heat loss through the skin capillaries can be minimized by constricting arterioles in the dermis. When cold stressed, contraction of erector pili muscles attached to the hair can generate body heat and contribute to the heat production.
- **Cutaneous sensation:** Skin contains sensory receptors which are sensitive to touch, pressure, temperature and pain. Upon stimulation, nerve impulses are generated which are transmitted to the brain for sensory perception.
- **Synthesis of vitamin D:** Exposure to the sunlight can convert a lipid based substances in the skin to vitamin D.
- **Excretion:** Skin serve as a minor excretory organ. Sodium chloride, urea, and aromatic substances such as garlic can be excreted in sweat.

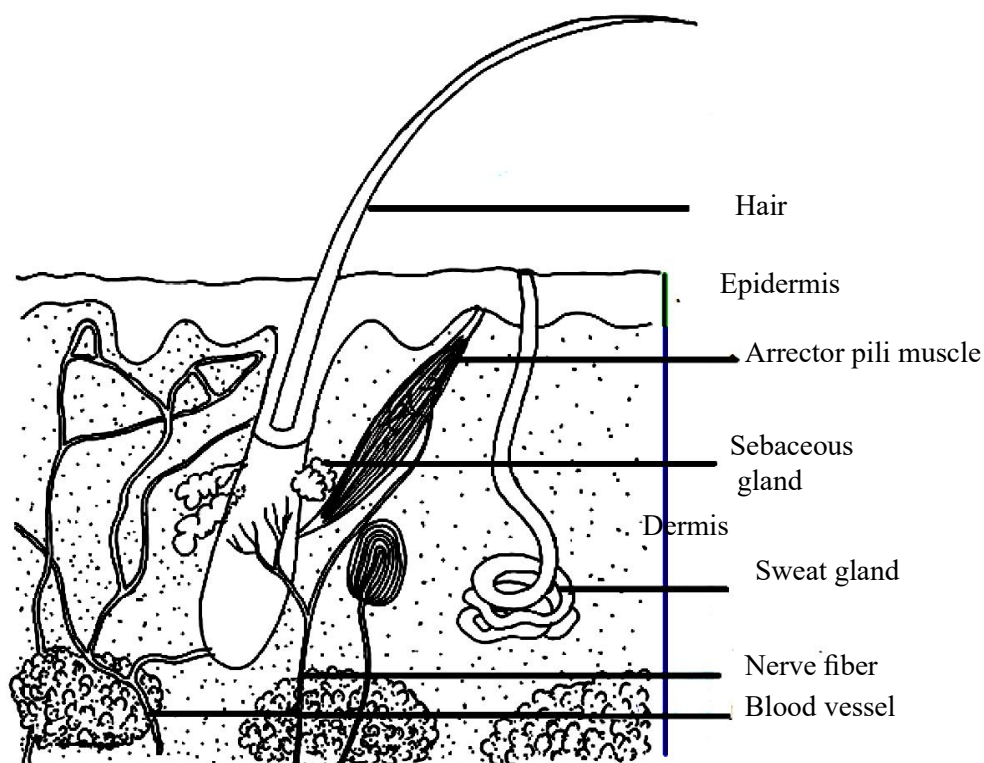

Figure 5.19: Typical structure of the skin

The role of human endocrine system

Endocrine system is one of the two basic systems for coordination and regulation of activities in the human body. Compared to the nervous system, endocrine control is mainly involved in slower but more precise adjustments in maintaining homeostasis in the body. The endocrine system functions through “chemical signaling” by hormones which are secreted by specific endocrine glands or endocrine cells.

Endocrine glands are ductless glands consisting of groups of specialized cells which secrete hormones (chemical messengers) that diffuse directly into the bloodstream and reach the specific target organs/tissues that may be located quite distantly. Diffusion of hormones from these endocrine glands to the bloodstream is facilitated by the extensive capillary networks surrounding the glands.

Hormone is a specific type of signaling molecules secreted by an endocrine gland/endocrine cells and travels in the blood and acts on specific target cells elsewhere in the body, changing the target cell functioning. Although a specific hormone can reach all body cells, only the cells (target cells) which have matching receptors for that hormone are responsive to the chemical signal. When the hormone binds to the specific receptor of the target cell, it act as a switch influencing chemical/metabolic reactions within the cell. Through chemical signals, hormones can communicate regulatory messages throughout the body.

Human endocrine system mainly consists of specific endocrine glands that are widely separated from each other. Location of endocrine glands of the human endocrine system is shown in the **Figure (Location of human endocrine glands)**. Endocrine glands of the human endocrine system include hypothalamus, pituitary gland, thyroid gland, parathyroid glands, adrenal glands, islets of Langerhans (in the pancreas), gonads, thymus gland and pineal gland. In addition to these endocrine glands, isolated endocrine cells are found in some organs and tissues (e.g. stomach, small intestine, kidneys etc.) which secrete specific hormones (e.g. isolated endocrine cells in the stomach secrete the hormone, gastrin).

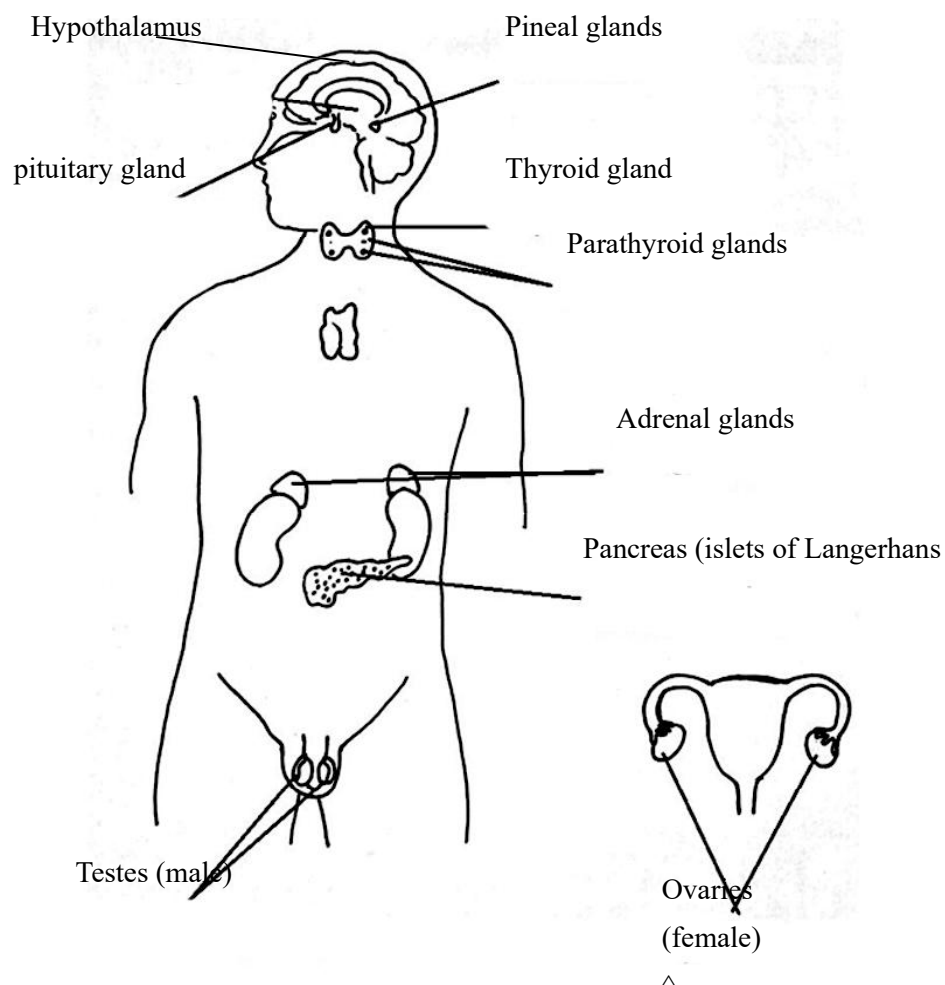

Figure 5.20: Location of human endocrine glands

Hypothalamus

Hypothalamus is located at the base of the fore brain just below the thalamus and connected to the pituitary gland. Seven hormones that are produced and released by the hypothalamus (five releasing hormones and two release inhibiting hormones), act on the anterior pituitary (target site). These hypothalamic hormones regulate the secretion of anterior pituitary hormones (Table Hypothalamic hormones that act on the anterior pituitary gland). Two other hormones produced

by the hypothalamus (oxytocin and antidiuretic hormone) are stored in the posterior pituitary until they are released into the bloodstream and act on specific target sites.

Table 5.3: Hypothalamic hormones that act on the anterior pituitary gland

Hypothalamic hormone	Function
Growth hormone releasing hormone (GHRH)	Stimulates the secretion of growth hormone (GH) from anterior pituitary
Thyrotropin releasing hormone (TRH)	Stimulates the secretion of thyroid stimulating hormone (TSH) from anterior pituitary
Corticotropin releasing hormone (CRH)	Stimulates the secretion of adrenocorticotrophic hormone (ACTH) from anterior pituitary
Gonadotropin releasing hormone (GnRH)	Stimulates the secretion of follicle stimulating hormone (FSH) and luteinizing hormone (LH) from anterior pituitary
Prolactin releasing hormone (PRH)	Stimulates the secretion of prolactin hormone from anterior pituitary
Prolactin inhibiting hormone(PIH)	Inhibits the secretion of prolactin hormone from anterior pituitary
Growth hormone release inhibiting hormone (GHRH)	Inhibits the secretion of GH and TSH from the anterior pituitary

Pituitary gland

Pituitary gland is situated in the fore brain just below the hypothalamus to which it is attached by a stalk. Pituitary gland consists of two main parts (anterior pituitary and posterior pituitary) which are actually two fused glands that perform different functions.

The anterior pituitary synthesizes specific hormones (**Table 5.4: Anterior pituitary hormones, their target sites and functions**). The anterior pituitary connects with the hypothalamus through portal blood vessels. In response to specific releasing hormones secreted from the hypothalamus (Table: Hypothalamic hormones that act on the anterior pituitary gland), anterior pituitary secretes its specific hormones to the blood stream. Some hormones secreted by the anterior pituitary redirect the chemical signals from hypothalamus to other endocrine glands. These anterior pituitary hormones are called tropic hormones (TSH, ACTH, FSH and LH) as their specific target site is another endocrine gland or endocrine cell. The hormone prolactin which is secreted by the anterior pituitary is not a tropic hormone as its target sites are non-endocrine tissues. Prolactin promotes only non-tropic effects. Growth hormone (GH) secreted by the anterior pituitary has a “tropic as well as non-tropic effects” as its target sites can be endocrine cells as well as non-endocrine cells. GH is the most abundant hormone synthesized by the anterior pituitary.

Table 5.4: Anterior pituitary hormones, their target sites and functions

Hormone	Target site	Function
Growth hormone (GH)	All body cells	Promotes tissue growth (especially bones and muscles) by stimulating protein synthesis; Regulates metabolism
Thyroid stimulating hormone (TSH)	Thyroid	Stimulates secretion of thyroid hormones (triiodothyronine and thyroxin); Stimulates growth of thyroid gland,
Prolactin	Mammary gland	Stimulates milk production; Together with other hormones promotes milk secretion by the mammary glands.
Adrenocorticotrophic hormone (ACTH)	Adrenal cortex	Stimulates secretion of adrenal cortex hormones (Glucocorticoid hormones)
Follicle stimulating hormone (FSH)	Ovary	Stimulates growth and development of ovarian follicle
	Testis	Stimulate spermatogenesis
Luteinizing hormone (LH)	Ovary	Ovulation; promote formation of corpus luteum in the ovary (structure formed after ovulation) and stimulates progesterone hormone secretion by the corpus luteum.
	Testis	Stimulates secretion of testosterone hormone

The posterior pituitary which is an extension of the hypothalamus connecting via axons, does not synthesize hormones but secretes two hypothalamic hormones (oxytocin and antidiuretic hormone) to the bloodstream. Oxytocin and antidiuretic hormone (ADH) synthesized in the hypothalamic neurons travel through the long hypothalamic axons that reach into the posterior pituitary. These hormones are stored in the axon ends located in the posterior pituitary until they are released into the blood stream in response to nerve impulses transmitted from the hypothalamus. The target sites and functions of the hormones secreted by the posterior pituitary are given in the Table 5.5 (**Posterior pituitary hormones, their target sites and functions**).

Table 5.5: Posterior pituitary hormones, their target sites and functions

Hormone	Target site	Function
Antidiuretic hormone (ADH)	Distal convoluted tubules of the nephrons and collecting ducts in the kidney	Stimulates resorption of water by increasing permeability to water
Oxytocin	Mammary gland	Stimulates milk ejection by stimulating contraction of smooth muscles
	Uterine muscles	Promotes parturition by contraction of smooth muscles

Thyroid gland

Thyroid gland is located in the neck just below the larynx and in front of the trachea. It has two lobes. Thyroid gland secretes triiodothyronine (T3) and thyroxin (T4) which are collectively called thyroid hormones. Thyroid hormones increase the basal metabolic rate and heat production; regulate the metabolism of carbohydrates, proteins and fats. Thyroid hormones are needed for normal growth and development of especially the skeletal and nervous systems. Thyroid hormones also help maintain normal blood pressure, heart rate and muscle tone and regulate digestive and reproductive functions. Calcitonin is another hormone secreted by the thyroid gland. Calcitonin helps to lower blood calcium ion level if it is raised above the normal limit. This hormone acts on bone cells and promotes storage of calcium within bone tissues. The hormone also acts on kidney tubules and inhibit calcium reabsorption enhancing calcium excretion.

Parathyroid glands

Parathyroid glands (a set four small glands) are embedded in the posterior surface of the thyroid gland located in the neck. Two glands are embedded in each lobe of the thyroid gland. Parathyroid glands secrete parathyroid hormone (PTH). Main function of the PTH is to promote high calcium levels in the blood by stimulating calcium reabsorption from the kidney tubules and calcium absorption through the small intestine. If these sources supply inadequate calcium, PTH acts on bone destroying cells and promotes release of calcium from the bones into the blood. PTH has the opposite effect of calcitonin hormone (released by the thyroid gland) on the blood calcium level.

Thymus gland

Thymus gland is located in the upper part of the chest, directly behind the sternum and between the lungs. Thymus gland secretes the hormone thymosin. Thymosin acts on the lymphocytes (originated from the stem cells in the bone marrow) and regulates development and maturation of T lymphocytes which are important components of specific immunity.

Pineal gland

Pineal gland is located in the brain. Melatonin secreted by the pineal gland is involved in the regulation of biological rhythms related to reproduction and daily activity levels. Melatonin seems to be associated with coordination of circadian and diurnal rhythms of many tissues and inhibition of growth and development of sex organs before puberty.

Adrenal glands

Adrenal glands are paired structures, one of which lies superior to each kidney. Each gland consists of two parts: adrenal cortex (outer) and adrenal medulla (inner). The structure and functions of these two parts are different. Hormones secreted by the adrenal cortex and the adrenal medulla can mediate the stress responses in the body.

The hormones mainly produced by the adrenal cortex are glucocorticoids and mineralocorticoids. These hormones mediate “long term stress responses” and participate in homeostatic regulation of metabolism. Glucocorticoids have a main effect on glucose metabolism and promote glucose synthesis from non-carbohydrate sources such as protein and fat so that more glucose is available in the blood circulation for cellular energy production. These hormones can promote breakdown of skeletal muscle proteins for synthesis of glucose when the body requires more glucose. Cortisol is the main glucocorticoid produced by the adrenal gland. Main mineralocorticoid produced by the adrenal gland is aldosterone which is involved in maintaining water and electrolyte balance. Aldosterone stimulates the reabsorption of sodium ions by the kidney tubules and excretion of potassium ions in the urine. As sodium reabsorption is accompanied by the water retention, blood volume and blood pressure can be increased. Hence aldosterone hormone is also involved in the regulation of blood volume and blood pressure.

The hormones produced in the adrenal medulla are adrenaline (epinephrine) and noradrenaline (norepinephrine) which could mediate ‘short term stress responses’. Upon extensive sympathetic nervous stimulation, adrenal medulla secretes these hormones which can potentiate the “fight or flight response” by increasing the heart rate and blood pressure, diverting blood to essential organs (i.e heart, brain, skeletal muscles) and increasing metabolic rate etc. The hormones secreted by adrenal medulla are mainly involved in increasing the availability of chemical energy for immediate use. These hormones promote glucose release into the circulating blood by increasing the rate of glycogen breakdown (in liver and skeletal muscles) and fatty acids release (from fat cells) for energy production within the body cells.

Islets of Langerhans in the pancreas

Pancreases can be considered an endocrine gland as well as an exocrine gland. It is located behind the stomach in the curve of the duodenum. The endocrine part of the pancreas is the islets of Langerhans which are clusters of cells scattered throughout the pancreas. These pancreatic islets mainly secrete two hormones, glucagon and insulin which control the blood glucose level by opposing actions. Alpha cells of the pancreatic islets secrete glucagon which mainly promote the blood glucose level increase. Beta cells of the pancreatic islets secrete insulin which promotes lowering of blood glucose level. Liver and skeletal muscles are the main target sites of these hormones (Refer the section on homeostatic control of blood glucose).

Gonads

Paired female gonads (ovaries) are located in the pelvic cavity. Paired male gonads (testes) lie in the scrotum. In addition to the reproduction, ovaries and testes have endocrine functions. (Refer the section on human male and female reproductive systems for more details).

Ovarian follicle produces the hormone estrogen. Corpus luteum (the structure formed from the ovarian follicle after ovulation) produces progesterone. These female sex hormones along with FSH and LH from the anterior pituitary regulate menstrual cycle, maintain pregnancy and prepare mammary glands for lactation. They also help establish and maintain feminine sexual characteristics. The ovaries also produce the hormone inhibin that inhibits secretion of FSH from anterior pituitary.

The main hormone produced and secreted by the testes (interstitial cells) is the male sex hormone, testosterone. Testosterone regulates production of sperm and stimulates the development and maintenance of masculine secondary sex characteristics. In addition, the testes (Sertoli cells) produce inhibin that inhibits secretion of FSH.

Feedback mechanisms related to the endocrine system

Variety of physiological processes in the human body including the actions of hormones on target cells are regulated by feedback mechanisms. Feedback refers to the regulation of a process by its output or end product.

Most hormonal controls in the human body use negative feedback mechanisms where accumulation of an end product of a process (the response to the stimulus) slows that process (reduces the effect of the initial stimulus). The endocrine gland will release its hormone into the blood only when the gland is stimulated and the response at the target site will in turn reverse or reduce the stimulus through the negative feedback. In the absence of stimulation, the blood level of hormone will

decrease. Some hormone levels in the blood can be directly controlled by the blood levels of the stimulus (e.g. insulin or glucagon by blood glucose levels). For example high blood glucose levels stimulate the release of insulin hormone (from the pancreas) to the circulating blood which acts on specific target tissues to lower the blood glucose level. When glucose level in the blood reaches normal range, blood glucose level can in turn directly control the secretion of insulin levels from the pancreas and prevent further lowering of the glucose level in the blood. (Refer the section on homeostatic control of blood glucose level).

A few hormonal regulatory systems operates using “positive feedback mechanism” which is a form of regulation in which an output (or end product) of a process speeds up that process thereby reinforcing or amplifying the change. Positive feedback mechanisms involving oxytocin hormone operate in childbirth and breast milk ejection. During labour, contractions of uterus are stimulated by oxytocin hormone released by the posterior pituitary. These contractions force the baby’s head into the uterine cervix stimulating its stretch receptors. In response to stimulation of stretch receptors, sensory neurons are stimulated again triggering more oxytocin release from the posterior pituitary enhancing contractions of the uterus. This process repeats until the baby is born. Afterwards oxytocin secretion stops as the stimulus (stretching of the cervix) is no longer present. Another positive feedback mechanism involving oxytocin hormone operates when releasing milk from the mammary glands (**Figure5.21: Positive feedback mechanism related to oxytocin hormone action**). During suckling, sensory neurons send the nerve impulses to the posterior pituitary triggering release of oxytocin hormone to the circulating blood. Then oxytocin acts on the mammary glands and induces contractions of smooth muscles in the mammary glands to release milk. Milk release increases the sensory stimulus forming a positive feedback that amplifies the stimulus. In response to the positive feedback, more oxytocin is released enhancing milk ejection

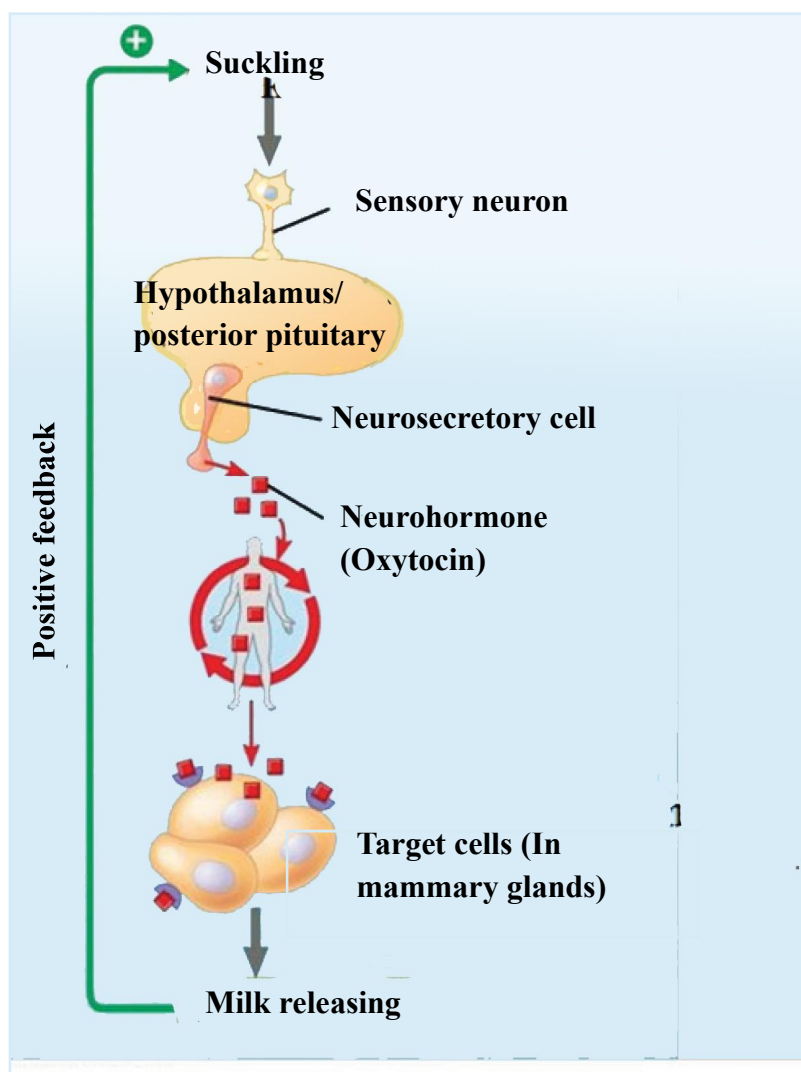

Figure 5.21: Positive feedback mechanism related to oxytocin hormone action

Some endocrine disorders in human

- Diabetes mellitus:** Diabetes mellitus is a common disorder associated with insulin hormone produced by the pancreatic islets of Langerhans. Primary sign of this disorder is the increase in blood glucose levels above the normal limits. High blood glucose levels lead to excretion of glucose with urine, excessive production of urine and the thirst. Diabetes mellitus is mainly classified into two types: Type 1 diabetes and Type 2 diabetes.

Type 1 diabetes was known as insulin dependent diabetes mellitus. This disorder usually appears in children and young adults. This is an autoimmune disorder caused by the destruction of beta cells of the islets of Langerhans by the immune system in the body. As

a result, insulin secretion is severely deficient or absent in the affected individuals. Genetic factors and environment factors seem to be associated with this disorder. Type 1 diabetes may be controlled by taking meals with less carbohydrates and fats, regular monitoring of blood glucose levels and periodic insulin injections.

Type 2 diabetes was known as non-insulin dependent diabetes mellitus. This condition is not dependent on insulin production. Even though insulin is produced and secreted into the blood, target cells fail to take up glucose from the blood. Hence blood glucose levels remain elevated but glucose may be deficient inside the body cells. The cause for this type of diabetes is multifactorial. Predisposing factors include obesity, lack of exercise (sedentary lifestyle), increasing age and genetic factors. Type 2 diabetes may be controlled by the diet with less carbohydrates and fats, balancing sugar intake with exercise and taking suitable medicine.

- **Hyperthyroidism and hypothyroidism:** These conditions are associated with abnormal secretion of thyroid hormones (T₃ and T₄) which may occur due to abnormal functioning of the thyroid gland and disorders of pituitary or hypothalamus. Persistence of these conditions may lead to enlargement of the thyroid gland (goiter).

Hyperthyroidism: This condition occurs due to exposure of body tissues to excessive levels of T₃ and T₄. Common effects include increased basal metabolic rate, weight loss, warm, sweaty skin and diarrhea. Some conditions lead to bulging of eyes (exophthalmos) and goiter. Treatment may include surgical removal of part or all of the thyroid gland and using medicine to block thyroid hormone synthesis.

Hypothyroidism: Insufficient secretion of thyroid hormones (T₃ and T₄) from the thyroid gland causes hypothyroidism. This can be due to lack of TSH production by anterior pituitary or iodine deficiency in diet. Common effects include low basal metabolic rate, weight gain, lethargy, dry, cold skin and constipation. The condition may be controlled by increasing dietary iodine intake or/and oral thyroid hormone treatment.

Maintenance of constant internal environment within limits in the human body

Homeostasis

Homeostasis is a steady state condition where body's internal environment remains relatively constant within narrow physiological limits despite significant changes in the external environment. Surroundings outside of the body are referred to as the external environment. Internal environment is the immediate surroundings of the body cells which provides the cells with the medium in which they have to live. Examples for the internal environment of the body are interstitial fluid and the blood. Many animals and humans exhibit homeostasis for a range of physical and chemical properties. For example, humans maintain a fairly constant body temperature, blood pH, blood glucose and blood osmolality within narrow physiological limits. Homeostasis is important for maintaining the internal environment in a steady and balance state and to establish optimum conditions for the human body.

Homeostatic control systems in the human body mainly depend on negative feedback mechanisms to maintain a constant level thereby preventing serious changes in the internal environment. Homeostasis is achieved by maintaining a variable (e.g. body temperature, blood glucose) at or near a particular value (set point). A fluctuation in the variable above or below the set point serves as the stimulus detected by a sensor (detector). When a signal is received from the sensor, a control center generates output that triggers a response, a physiological activity that helps to return the variable towards the set point level. The set point level is achieved by the negative feedback control of the stimulus by the response.

Homeostatic regulation of body temperature in humans

As the temperature affects the rate of chemical reactions, homeostatic control keeps the human body at optimum operating temperature. The normal body temperature of man is typically 37°C (36.5°C – 37.5°C). Human body temperature is controlled by negative feedback mechanisms. If the body temperature is outside the normal range, a group of nerve cells in the hypothalamus of the brain (“body's temperature control center”) functions as a thermostat and responds to the temperature increase or decrease by activating heat loss mechanisms or promoting heat gain mechanisms respectively until the body temperature reaches the preset level.

High peripheral temperature (e.g. when the person is in hot surroundings) is detected by warm receptors in the skin. High deep body temperature (e.g. due to high body heat generation after exercise) is detected by hypothalamic temperature sensitive nerve endings when warm blood pass through the hypothalamus. These nerve impulses are sent to the “body’s temperature control center” (thermostat) in the hypothalamus. In response to the increase in body temperature above the preset level, the ‘thermostat’ in the hypothalamus sends impulses to activate heat loss mechanisms and to inhibit heat gain mechanisms that lower the body temperature until the set point.

The following heat loss mechanisms promote the decrease in body temperature.

- dilation of blood vessels in the skin which causes filling of blood capillaries with warm blood and radiating heat from the skin surface
- increase sweat secretion from the sweat glands which promotes heat dissipation through evaporative cooling

When body temperature is within the normal range again, the warm temperature sensitive receptors are no longer stimulated and their signals to the ‘hypothalamic thermostat’ stops due to the negative feedback mechanism. Then, additional heat loss mechanisms stop and blood flow to the peripheries returns to normal.

Low peripheral temperature (when in cold surroundings) is detected by cold receptors in the skin. Low deep body temperature (due to more heat loss and low heat generation in the body) is detected by temperature sensitive nerve endings in the hypothalamus. These nerve impulses are sent to the body’s temperature control center (thermostat) in the hypothalamus. If the body temperature decreases below the preset level, the thermostat in hypothalamus sends impulses to activate heat gain mechanisms and inhibit the heat loss mechanisms thereby increasing the body temperature until the preset point.

The following heat conservation and heat gain mechanisms promote the increase in body temperature.

- constriction of blood vessels in the skin which divert the blood from the skin to deeper tissues thereby reducing heat loss through the skin surface
- shivering: rapid repetitive contractions of skeletal muscles to generate heat
- contracting hair erector muscles to generate heat to some extent
- stimulating secretions of more thyroid hormones (e.g. thyroxin) and adrenalin into the blood which increase the metabolic rate and cellular metabolism (especially oxidation of fat in the liver) to produce more heat

When body temperature returns to the normal range, the cold temperature sensitive receptors are no longer stimulated and their signals to the hypothalamic thermostat stop due to negative feedback mechanism. Then, additional heat generating mechanisms in the body stop and blood flow to the peripheries returns normal.

Homeostatic regulation of blood glucose level

In humans, normal blood glucose level is 70 – 110 mg/100 mL (while fasting) which is sufficient for immediate needs of the body cells. The blood glucose levels can fluctuate throughout the day within physiological limits in non-diabetic persons. In the human body, blood sugar levels are homeostatically controlled by opposing actions of two hormones secreted by the pancreas: insulin and glucagon.

High blood glucose levels exceeding the normal limits, stimulate the secretion of insulin hormone from beta cells of the islets of Langerhans into the circulating blood. Insulin acts on specific target tissues to promote lowering of the blood glucose level. Insulin in the circulating blood stimulates transport of glucose into the body cells and use of glucose by body cells for ATP production (glucose may be broken down into carbon dioxide and water), conversion of glucose to glycogen in liver and skeletal muscle cells for storage, and conversion of glucose to fatty acids and storage of fat in adipose tissues. When glucose level in the blood reaches normal range, blood glucose level can in turn directly control the secretion of insulin levels from the pancreas through negative feedback. This mechanism prevents further lowering of the glucose level in the blood beyond the normal limits.

Low blood glucose levels below the normal limit, stimulate the secretion of glucagon from alpha cells of the islets of Langerhans into the circulating blood. Glucagon acts on specific target tissues to promote increase of the blood glucose level. Glucagon promotes the breakdown of glycogen in the liver and skeletal muscles and release of glucose into blood. When glucose level in the blood reaches normal range, blood glucose level can in turn directly control the secretion of glucagon levels from the pancreas through negative feedback which prevents further increasing of the glucose level in the blood beyond the normal limits.

Osmoregulation

Osmoregulation is the process of maintaining water and salt balance (osmotic balance) across membranes within the body's fluids relative to the surrounding. When there is osmotic balance, amount of water and concentration of salts is same inside and outside the cells. Osmoregulation is important for organisms to keep a constant, optimal osmotic pressure within the body. In the humans, osmoregulation ensures that the total blood volume and the concentration of dissolved substances in the plasma and tissue fluids remain constant within a favourable range.

In the human body, osmotic balance is achieved by two ways: controlling the amount of water and controlling the amount of salt gained and lost by the body. Blood water homeostasis is controlled by the hypothalamus. Hypothalamus contains osmoreceptors which can detect the osmolarity of the blood passing through the brain. In response to the osmolarity (or osmotic pressure) of the blood, the hypothalamus controls the sensation of thirst, and secretion of the hormone ADH from the posterior pituitary.

When blood osmolarity is increased beyond the physiological limits, it is sensed by the osmoreceptors in the hypothalamus which stimulates the posterior pituitary to release ADH to the blood circulation. ADH acts on the kidney tubules and stimulates the reabsorption of water through distal convoluted tubules of the nephrons and collecting ducts producing concentrated urine. When blood osmolarity is decreased, ADH is not secreted, so water reabsorption through distal convoluted tubules of the nephrons and collecting ducts stop thereby producing diluted urine. In addition, low blood volume and low blood sodium ions stimulate the kidneys to produce angiotensin II which stimulates the adrenal cortex to secrete aldosterone hormone. Aldosterone stimulates the reabsorption of sodium ions by the kidney tubules which is accompanied by the water retention, thereby increasing blood volume and blood pressure. Hence, kidneys play a major role in osmoregulation in the human body.

Role of the liver in homeostasis.

Liver is an active organ and plays an important role in maintaining homeostasis of the human body. The functions of the liver include the following.

- **Carbohydrate metabolism:** The liver plays an important role in maintaining blood glucose levels within normal ranges. When blood glucose is increased (e.g. after a meal), glucose is stored as glycogen under the stimulation of insulin. If blood glucose level is reduced (e.g. starvation), glycogen is converted back to glucose under the influence of glucagon hormone.
- **Fat metabolism:** When the body needs excess energy, fats that are stored in the liver cells are metabolized to produce ATP
- **Protein metabolism:** In the liver cells, nitrogen part of some amino acids that are not needed for new protein synthesis are removed (deamination) and excreted in urine or transferred to carbohydrates to synthesize new nonessential amino acids (transamination). Liver also synthesizes plasma proteins (e.g. albumin, globulins) from amino acids.
- **Breakdown of erythrocytes and defense against microbial infections:** In humans, liver is a site for red blood cell breakdown. Macrophages located in the liver are involved in microbial defense.
- **Detoxification of drugs and toxicants:** The liver plays an important role in detoxification.
- **Production of heat:** Liver is the major heat producing organ of the body as it has a high metabolic rate.

- **Storage of nutrients:** Glycogen, fat soluble vitamins (A, D, E,K), some water soluble vitamins- B12 and essential metals such as iron, copper are stored in liver.
- **Inactivation of hormones:** Some hormones are inactivated by the liver after their biological action.
- **Secretion of bile:** Liver cells synthesize the components present in the bile which is important in fat digestion and excretion of bilirubin (a breakdown product of red blood cells).

Reproduction

Modes of reproduction seen among animals

Reproduction is a biological process through which a new generation of individuals is produced from the existing organisms. Two modes of reproduction are found among the animals: Asexual reproduction and Sexual reproduction. For the most animals, reproduction is mainly or entirely sexual. Several forms of asexual reproduction are also seen especially among invertebrates.

Asexual reproduction

Asexual reproduction is a mechanism through which new individuals are generated from a single parent without the fusion of egg and sperm. Asexual reproduction relies entirely on mitotic cell division. Asexual reproduction allows the rapid multiplication of individuals from single parents. Hence no time or energy is spent in searching the mates for the reproduction. The produced offspring are genetically identical to each other and to the single parent. Several methods of asexual reproduction are found among invertebrates. They include budding, fragmentation and regeneration, and parthenogenesis.

- **Budding:** Budding is a form of asexual reproduction in which new individuals arise from outgrowths of the animal. e.g. Hydra – A localized mass of mitotically dividing cells, develops into a small Hydra, which can eventually detach from the parent.
- **Fragmentation and regeneration:** This is a form of asexual reproduction which involves breaking of the body or part of the body into several pieces, followed by the growth of a separate individual from each piece. Each fragment develops into a complete animal by regrowth of lost body parts (regeneration). e.g. Certain annelid worms, numerous sponges, cnidarians.
- **Parthenogenesis:** This is an unusual form of asexual reproduction in which an egg develops into a complete individual without being fertilized. Among invertebrates, parthenogenesis occurs in some animals such as bees, ants, aphids and wasps. The progeny can be haploid or diploid. In honey bees – males (drones) are fertile haploid adults that develop through parthenogenesis, whereas females including both sterile workers and the fertile queen, are diploid adults that developed from fertilized eggs. Parthenogenesis has also been observed very rarely among vertebrates (e.g. some lizards and fish).

Sexual reproduction

Sexual reproduction is a mechanism through which a new individual is developed from a diploid zygote as a result of the fusion of two haploid gametes (the sperm and the egg) which are produced by two individuals (the male and the female parents respectively). The female gamete, the egg, is large and non-motile, while the male gamete, the sperm, is generally much smaller and motile. The fusion of the female and male gametes forms a diploid cell called the zygote. The animal that develops mitotically from a zygote can in turn give rise to gametes by meiosis. For the most animals, reproduction is mainly or entirely sexual.

- **Gamete formation:** In animals, reproductive cells called gametes (sperms and eggs) are the vehicles that transmit genes from one generation to the next. Each gamete is a haploid, unicellular reproductive cell. Gametes in animals are formed by meiosis in special organs called gonads.
- **Bisexual organism and Unisexual organism:** In a bisexual organism (Hermaphrodite), one individual has both female and male reproductive structures and therefore is able to produce both male and female gametes by the same individual. e.g. Earthworms. In unisexual organisms (dioecious), one individual bears either male or female reproductive structures. Therefore production of male or female gametes occurs in separate organisms. e.g. Humans
- **Fertilization:** Union of egg and sperm (gametes) culminating in fusion of their nuclei is called fertilization. Fertilization can be either external or internal.

External fertilization occurs in aquatic environments. In species with external fertilization, the female releases eggs while the male releases sperm into the external environment and fertilization occurs in the water. A moist habitat is almost always required for external fertilization both to prevent the gametes from drying out and to allow the sperm to swim toward the eggs. e.g. Many invertebrates, amphibians, most bony fish.

In internal fertilization, sperms are deposited in or near the female reproductive tract and fertilization occurs within the female reproductive tract. e.g. insects, reptiles, mammals. Internal fertilization is an adaptation that enables sperm to reach an egg even when the environment is dry. The male copulatory organ delivers sperm and the female reproductive tract often has receptacles for storage and delivery of sperm to mature eggs. Internal fertilization is typically associated with the production of fewer gametes than external fertilization but results in the survival of a higher fraction of zygotes. Internal fertilization often provides greater protection to the embryos. Many animals show parental care. Internally fertilized eggs of birds and other reptiles possess shells and internal membranes that protect against water loss and physical damage. Some retain the embryo for a portion of any development within the female reproductive tract.

Significance of asexual reproduction and sexual reproduction

Asexual reproduction and sexual reproduction are important biological processes to ensure existence of a species.

Asexual reproduction allows rapid multiplication of individuals from single parents. Hence no time or energy is needed to be spent in searching mates for the reproduction. In asexual reproduction, there is no or very little genetic variation within a population as the produced offspring are genetically identical to each other and to the single parent. Therefore, asexual reproduction would be more advantageous in stable, favorable environments as it can propagate successful genotypes specifically. However, any mutation in the parent cell, can cause harmful effects on the survival ability of the offspring in changing environments. If there is a harmful mutation in the organisms, environment changes could be deadly to all the individuals in the population.

Unlike asexual reproduction, sexual reproduction results in the production of a unique offspring by combining genetic materials from two parents. Meiotic recombination during sexual reproduction helps produce varied genotypes. Unique gene combinations formed during sexual reproduction would be advantageous as this can enhance reproductive success and survival of a species in changing environments. Beneficial gene combination arising through recombination may speed up adaptation. During sexual reproduction, shuffling of genes might allow a population to clear sets of harmful genes more readily which would enhance the survival of the species.

Structure and Function of the Human Male Reproductive System

Main internal reproductive structures of a male consist of gonads (testes) which produce sperm and reproductive hormones, epididymis which store mature sperms, accessory glands that secrete products required for sperm movement and ducts that transport the mature sperm and glandular secretions. The external reproductive organs of a male are the scrotum and penis.

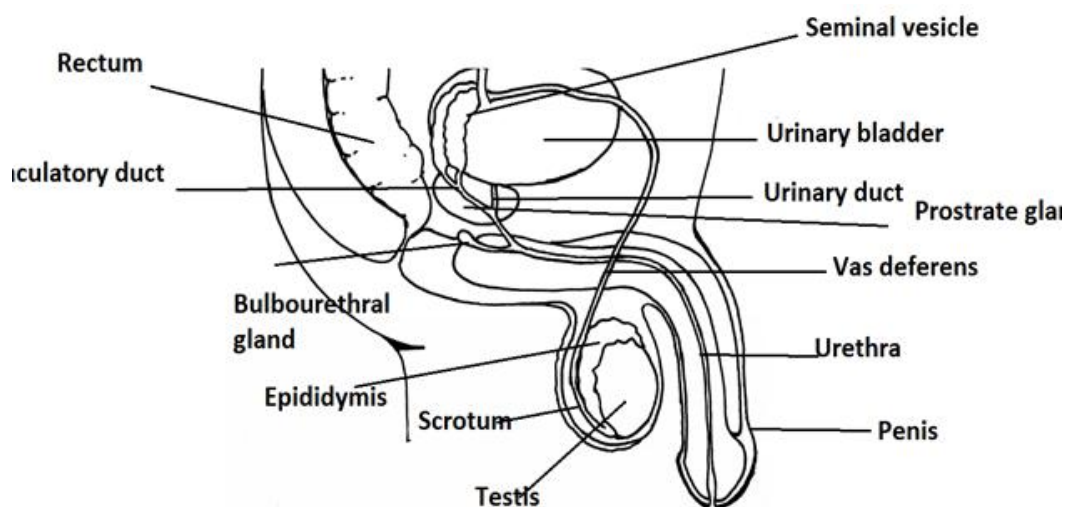

Figure 5.22: The gross structure of male reproductive system. (For orientation, some non-reproductive structures are also labelled)

Scrotum: Scrotum is a pouch formed by a fold of the body wall. Scrotum is divided into two compartments. Each compartment contains one testis, one epididymis and part of the spermatic cords which suspend the testis in the scrotum.

- Testes:** The testes are found within the scrotum which allows the maintenance of the testis temperature 2°C below the core body temperature. Sperms are produced properly only when the testes are cooler than the rest of the body. The testes develop in the abdominal cavity and descend into the scrotum just before birth. The testes are cooled by their position outside the abdominal cavity and the thin covering of the scrotum. Each testis contains many lobules. Within each lobule there are highly coiled (convoluted) loops called **seminiferous tubules**. Sperms are produced within these tubules. Different cells that undergo spermatogenesis are surrounded and connected to special type of supporting cells (**Sertoli cells**) located in the seminiferous tubule. Sertoli cells extend from the wall of the seminiferous tubules to the lumen. These cells secrete the hormone inhibin and nourish and provide attachment for cells that are in different stages of spermatogenesis. Groups of cells called Leydig cells (or interstitial cells) are present in the connective tissue between the seminiferous tubules. **Leydig cells** secrete the hormone testosterone and other androgens after puberty which promote spermatogenesis in the tubules. The seminiferous tubules combine to form a single tubule (duct) at the upper part of the testes.
- Epididymis:** Epididymis is the tightly packed mass that is formed by the repeatedly folded long duct originated from combined seminiferous tubules in the testis. From the seminiferous tubules, the sperm pass into the epididymis. Since it is very long (about 6 m

in length), it takes about 3 weeks for sperm to travel the length of this duct. During this time the sperms become matured and motile. Matured sperms are stored within the epididymis until ejaculation.

- **Vas deference, ejaculatory duct, urethra and penis:** During ejaculation, sperm are propelled from each epididymis through a muscular duct, the **vas deferens**. Each vas deferens (one from each epididymis) extends around and behind the urinary bladder, where it joins a duct from a seminal vesicle, forming a short **ejaculatory duct**. The ejaculatory ducts open into the urethra which is the passageway for both urinary excretion and delivery of sperms in semen into the female reproductive tract. The urethra runs through the penis and opens to the outside at the tip of the penis which contains erectile tissues derived from modified veins and capillaries.

Spermatogenesis

Spermatogenesis is the process of male gamete formation which includes formation of spermatocytes from a spermatogonium, meiotic division of the spermatocytes, and transformation of the four resulting spermatids (from each spermatocyte) into spermatozoa (sperm). Spermatogenesis occurs within the seminiferous tubules of the testes. The time taken to produce mature sperm cells from a specific spermatogonia in a seminiferous tubule is about seven weeks from start to finish.

The formation and development of sperms is continuous and inexhaustible in adult human males. Cell division and maturation during gametogenesis occur throughout the seminiferous tubules. Hundreds of millions of sperm are produced each day by spermatogenesis. In contrast to oogenesis (discussed later), in spermatogenesis all four cells produced during meiosis of each spermatocyte develop into mature gametes. Spermatogenesis starts at puberty and occurs throughout life. Spermatogenesis produces mature sperms from precursor cells in a continuous sequence.

Main steps in Spermatogenesis

- The stem cells ($2n$) that give rise to sperms (Spermatogonial stem cells) arise from mitotic division and differentiation of primordial germ cells in the embryonic testes. These stem cells are situated near the edge of the seminiferous tubules. In mature testis, their progeny moves inward as they pass through the different stages of maturation.
- In mature testes, the stem cells divide mitotically to form Spermatogonia ($2n$), which in turn generate primary spermatocytes ($2n$) by mitosis.
- Each primary spermatocyte gives rise to four spermatids (n) through meiosis (meiosis I and II), reducing the chromosome number from diploid ($2n=46$ in humans) to haploid ($n=23$).
- These spermatids differentiate into sperms with its characteristic head, midpiece and tail.
- The sperms are released into the fluid-filled lumen of the tubule and they travel along the tubule into the epididymis, where they become mature and motile.

After puberty, Leydig cells present between the seminiferous tubules secrete the hormone testosterone which promotes spermatogenesis. Different cells that undergo spermatogenesis are surrounded and connected to special type of supporting cells called Sertoli cells. These cells extend from the wall of the seminiferous tubules to the lumen. These cells secrete inhibin hormone and nourish and provide attachment for cells that are in different stages of spermatogenesis.

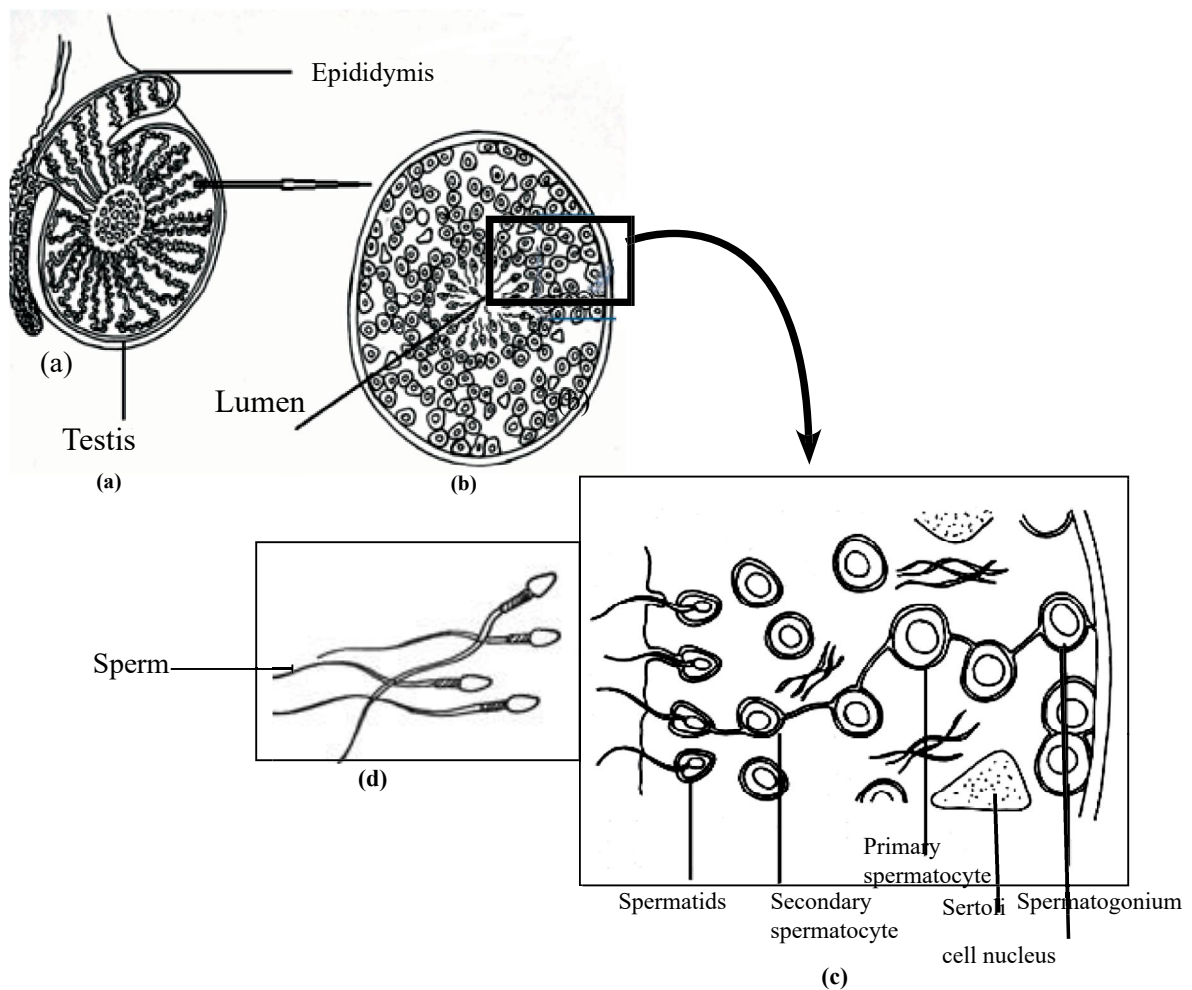

Figure 5.23: (a) T.S of testis (b) T.S of Seminiferous tubule (c) spermatogenesis (d) mature sperm released into lumen of seminiferous tubule

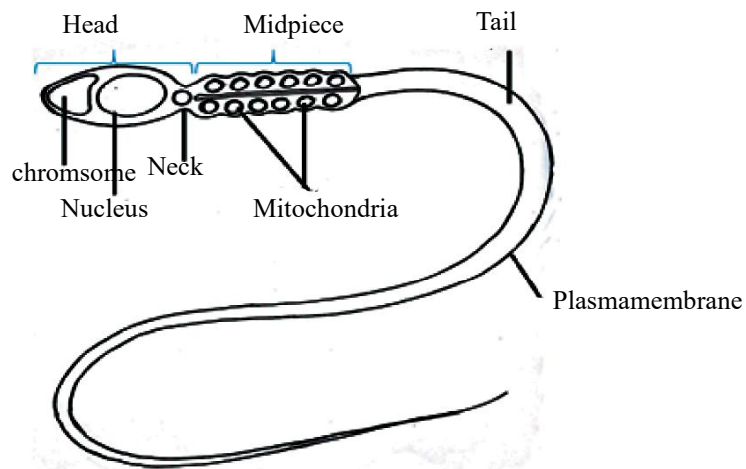
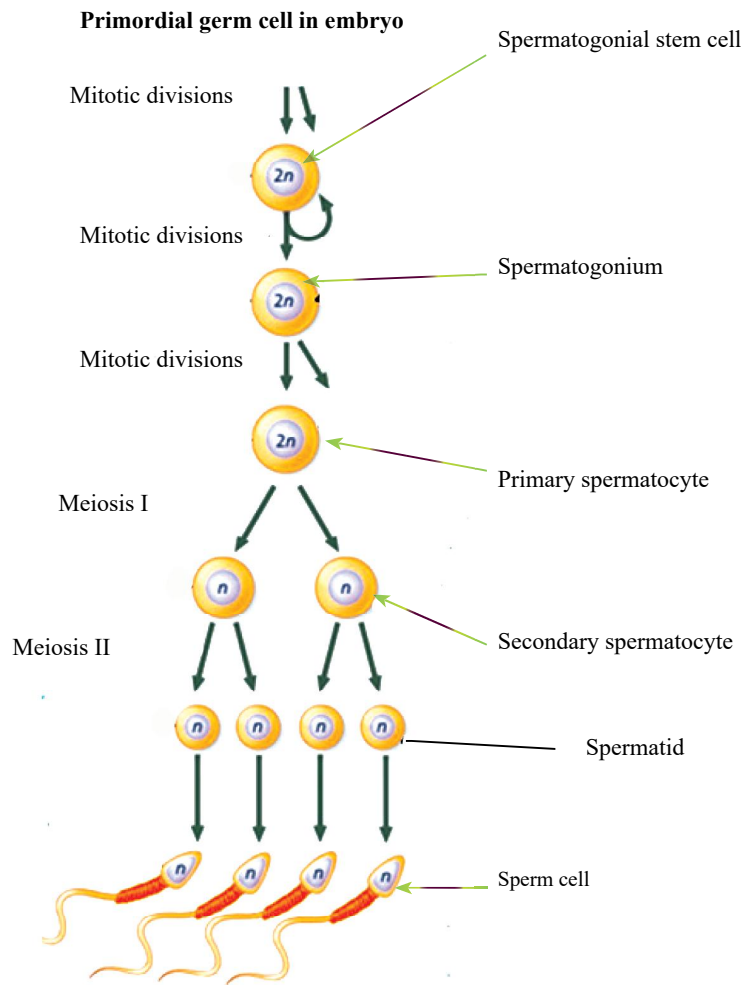

Figure 5.24: -Basic structure of the sperm

Each sperm is made up of three main parts, the head, midpiece (body) and tail.

Head of the sperm contains the haploid nucleus carrying the paternal genetic material. A special vesicle called the acrosome is present at the anterior end of the head. It contains hydrolytic enzymes such as trypsin and hyaluronidase that help the sperm to penetrate the outer layers of the ovum. Midpiece of the sperm contains many mitochondria that provides ATP necessary for the movement of the tail.

The tail of the sperm contains a long flagellum with typical 9+2 arrangement of microtubules. It is produced by the centriole found near the base of the nucleus. The tail enables the sperm to swim along the female reproductive tract towards an ovum.

Semen

The semen is the fluid that contains a mixture of sperms and the secretions of three sets of accessory glands. The semen is discharged from the urethra during ejaculation. Usually a normal ejaculate contains about 2-5 mL of semen and the sperm count in the semen may be in the range of 40-100 million/mL. Normally, the sperms comprise less than 10% of the final ejaculate. Main fraction of the semen is made up of secretions from seminal vesicles and the prostate gland.

The semen contains several components such as mucus, enzymes, prostaglandins, ascorbic acid, citrate and fructose which promote the survival of sperm. The semen provides a liquid medium for the sperm movement and also helps to neutralize the acidity in the female reproductive tract. The life expectancy of a sperm is about 48-72 hours after ejaculation.

Accessory glands associated with the male reproductive system

There are three sets of accessory glands that produce secretions necessary for sperm survival and movement. They are seminal vesicles, prostate gland and bulbourethral glands.

- **Seminal vesicles:** They are a pair of two small pouches that produce a thick, yellowish fluid that is expelled during ejaculation. Seminal fluid is alkaline to protect the sperm in the acidic environment of the vagina. It contains mucus, fructose (that provides most of the sperm's energy), a coagulating enzyme (helps semen coagulates after ejaculation), ascorbic acid and local regulators called prostaglandins. This fluid contributes to about 60% of the volume of semen. Each seminal vesicle opens into a short duct that joins the corresponding vas deference to form an ejaculatory duct.

- **Prostate gland:** This gland is found below the urinary bladder. It secretes a thin, milky fluid directly into the urethra through small ducts. This milky secretion contains coagulants, anticoagulant enzymes and citrate which is a sperm nutrient. This fluid contributes to about 30% of the volume of semen.
- **Bulbourethral glands:** They are a pair of small glands found along the urethra below the prostate. These glands secrete a clear alkaline mucus that is able to neutralize any acidic urine remaining in the urethra and lubricates the lining of the urethra.

Hormonal control of the male reproductive system

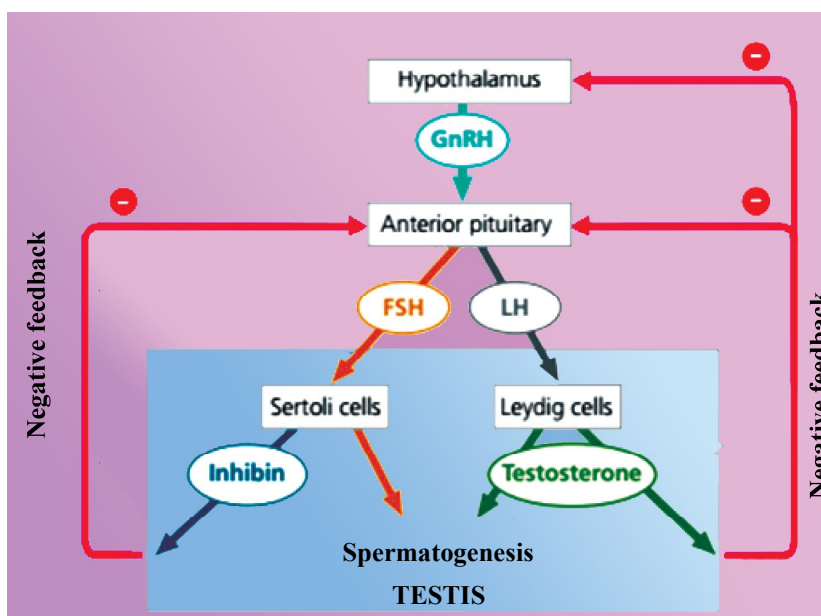

Figure 5.25: Hormonal control of the male reproductive system

- In males, in response to the release of GnRH from the hypothalamus (just before puberty), results in the release of FSH and LH by the anterior pituitary. Rising levels of the FSH and LH hormones at puberty promotes mature functioning of the male reproductive organs. The hormones regulate the development, growth, pubertal maturation and reproductive processes of the body.
- FSH and LH hormones direct spermatogenesis by acting on different types of cells in the testis.
 - FSH stimulates Sertoli cells to nourish the developing sperm.
 - LH causes Leydig cells to produce testosterone and other androgens to promote spermatogenesis.
- Two negative-feedback mechanisms control sex hormone production in males.

- Testosterone inhibits GnRH, FSH and LH in blood through its effect on the hypothalamus and anterior pituitary.
- Additionally inhibin produced by Sertoli cells, acts on anterior pituitary gland to reduce FSH secretion.
- These negative-feedback circuits maintain testosterone and other androgen levels in the normal range.

Structure and Function of the Human Female Reproductive System

Main internal structures of the female reproductive system consists of two ovaries (female gonads), two oviducts, uterus and vagina.

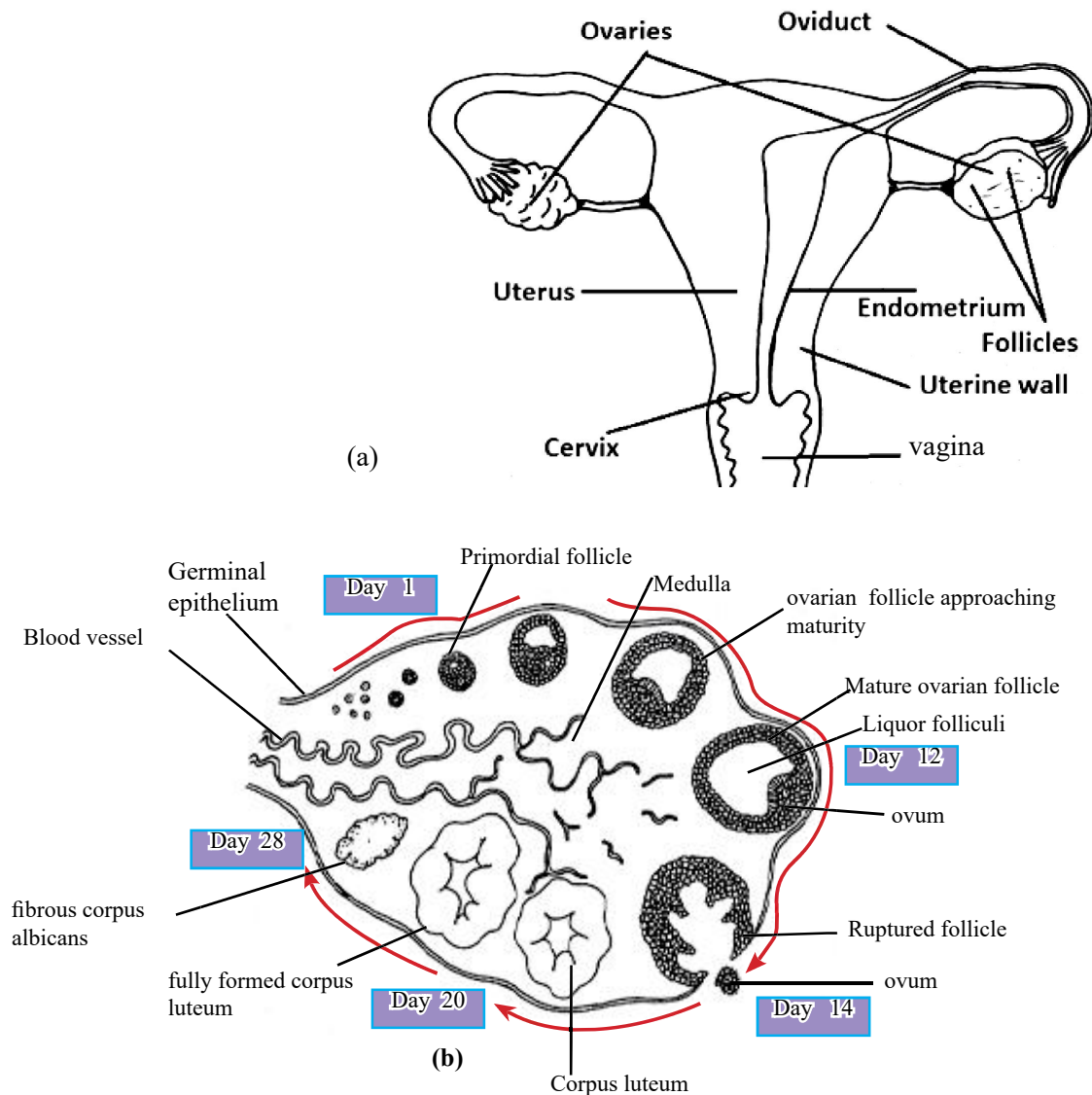

Figure 5.26: (a) The gross structure of the female reproductive system

Ovaries: The female gonads are the two ovaries. They are found on either side of the uterus and are held in place in the abdominal cavity by ligaments. In the ovary, female gametes are stored and developed prior to ovulation. Ovaries also produce female sex hormones that are needed for physiological changes during the reproductive cycle.

The ovaries have two tissue layers: outer the cortex and inner the medulla. The outer layer of each ovary consists of connective tissues covered by germinal epithelium. The outer layer contains ovarian follicles in various stages of maturity. Each follicle consists of an oocyte, which is a partially developed egg surrounded by support cells. Support cells protect and nourish the oocyte during its development. The ovum is discharged from the ovary at secondary oocyte stage of oogenesis with the first polar body. This secondary oocyte divides into the mature ovum (egg) and a second polar body if a sperm penetrates the secondary oocyte. Human ovum is a round cell with 23 maternal chromosomes and relatively large cytoplasm and is surrounded by numerous supporting cells. In addition, there is a clear layer present between plasma membrane of the ovum and the supporting cells.

Oviducts: The oviduct or the fallopian tube extends from the uterus toward a funnel like opening at each ovary. The dimensions of this tube vary along its length (near the uterus is narrow as a human hair). After ovulation, cilia on the inner epithelial lining of the oviduct help collect the egg by drawing fluid from the body cavity into the oviduct. Then with the help of wave like contractions of the oviduct the cilia convey the egg down the oviduct to the uterus.

Uterus: The uterus or the womb is a thick, pear shaped chamber. Its walls are muscular, which allows it to expand during pregnancy to accommodate the fetus and its inner lining (endometrium) is highly vascularized. The distal end of the uterus narrows to form a neck, called the cervix that opens into the vagina.

Vagina: This is a muscular but elastic chamber with a stratified epithelium. The vagina connects external and internal organs of reproduction. It is the site where sperm is deposited and also serves as the birth canal.

Oogenesis

In the human female, the development of mature oocytes takes a long time. Immature eggs are formed in the ovary of a developing female embryo. But these eggs complete their development many years or even decades later. In oogenesis, cytokinesis during meiosis is unequal, with almost all the cytoplasm segregated to a single daughter cell. This large cell develops to become the egg. The other products of meiosis, which are smaller cells are known as polar bodies. These polar bodies eventually degenerate. Unlike spermatogenesis, the mitotic divisions that occur during

oogenesis in human females are thought to be complete before birth and the production of mature gametes ceases at about the age 50 years. Unlike in spermatogenesis, during oogenesis there are also long interruptions.

Main steps in oogenesis

- Oogenesis begins in the female embryo with the mitotic division of primordial germ cells that give rise to oogonia.
- Then oogonia divide by mitosis to form cells that begin meiosis, but stops at prophase I before birth.
- Each of these developmentally arrested cell is called a primary oocyte. Each primary oocyte is found within a small follicle, a cavity lined with protective cells. At birth, the ovaries together contain about 1-2 million primary oocytes. Out of these about 500 fully mature between the puberty and the menopause.
- Beginning at puberty, follicle stimulating hormone (FSH) periodically stimulates a small group of follicles to resume growth and development. Out of these only one follicle fully matures each month. During this time the primary oocyte within the follicle completes meiosis I and produces a secondary oocyte and the first polar body. Then the meiosis II starts, but stops at the metaphase.
- The secondary oocyte arrested in meiosis II is released at ovulation (with the first polar body), when its follicle breaks open.
- If a sperm penetrates the secondary oocyte, meiosis II completes and the secondary oocyte divides into the mature ovum and a second polar body. Both meiotic divisions involve unequal cytokinesis, with the smaller cells becoming polar bodies which will degenerate eventually. If a sperm penetrates, there is a single mature egg (ovum) containing a sperm head at the end of oogenesis. The fusion of the haploid nuclei of the sperm and the ovum is called fertilization.
- The ruptured follicle left behind after ovulation develops into the corpus luteum. Corpus luteum secretes estradiol and progesterone hormones which help to maintain the uterine lining during pregnancy.
- If the egg is not fertilized, the corpus luteum degenerates and leaves a small permanent scar of fibrous tissue called corpus albicans on the ovary surface.
- A new follicle matures during the next cycle.

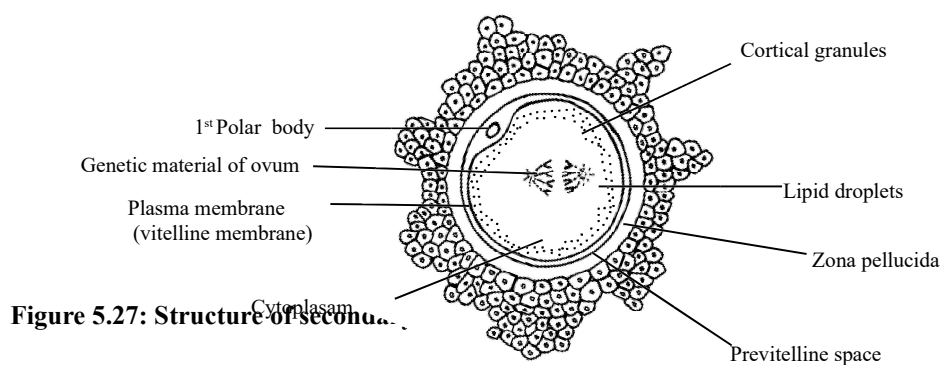

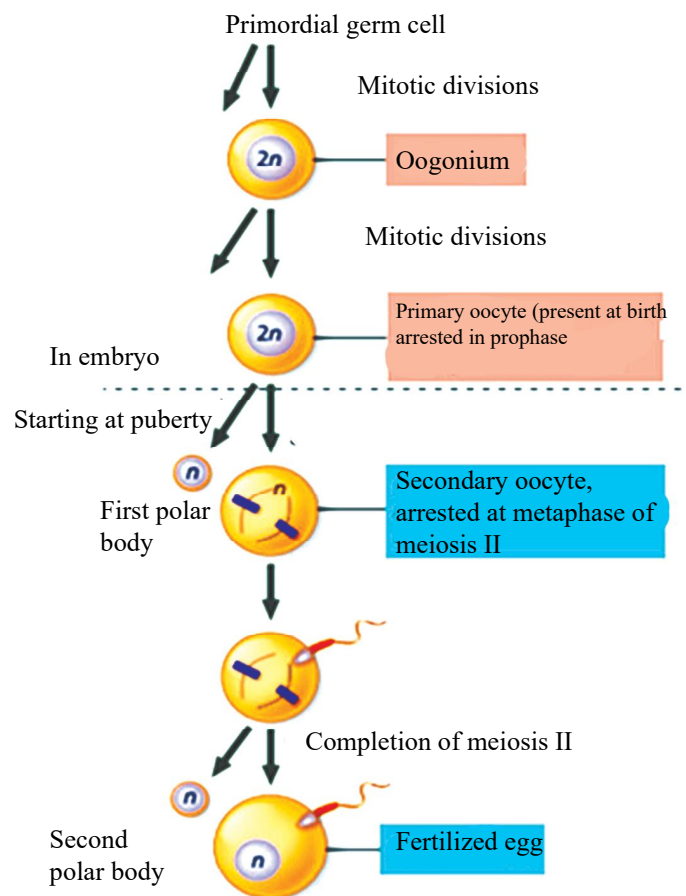
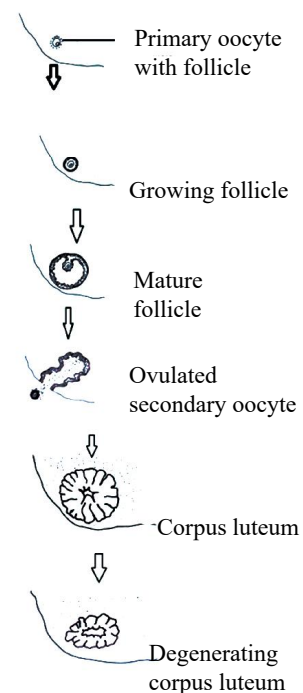

Figure 5.28: The process of oogenesis

Hormonal control of the human female reproductive cycles

Although males produce sperms continuously, females produce ova in cycles. There are two linked reproductive cycles in a human female during their reproductive years; the ovarian cycle and the uterine cycle (or the menstrual cycle). The uterine cycle consists of changes that occur about once a month in the uterus and these cyclic changes in the uterus are controlled by the ovarian cycle, which is cyclic events that occur in the ovaries. Both of these cycles are regulated by hormonal activities which link the two cycles, synchronizing ovarian follicle growth and ovulation with the establishment of a uterine lining which supports the development of embryo.



1. Ovarian cycle

- Ovarian cycle comprises follicular phase and luteal phase.
- The period during which the follicle grows and the oocyte matures is referred to as the follicular phase. At the beginning of follicular phase, GnRH from the hypothalamus stimulates the anterior pituitary to secrete small amounts of FSH and LH.
- FSH stimulates follicle growth, aided by LH.
- Cells of the growing follicle start to make estradiol hormone. Therefore the estradiol level rises slowly during the follicular phase. The low levels of estradiol inhibit the secretion of gonadotropin hormones from the anterior pituitary (negative feedback) so that LH and FSH are kept at relatively low levels in the follicular phase.
- When estradiol secretion by the growing follicle starts to increase sharply, high levels of estradiol stimulate the hypothalamus to increase GnRH secretion which in turn stimulates the anterior pituitary to sharply rise the FSH and LH secretion especially producing a LH surge (through positive feedback mechanism).
- By this time the maturing follicle, containing a fluid-filled cavity has enlarged, forming a bulge at the surface of the ovary. About a day after the LH surge, the follicular phase ends at ovulation. In response to both FSH and the peak in LH level, the follicle and adjacent wall of the ovary rupture, releasing the secondary oocyte which is called ovulation.
- The luteal phase of the ovarian cycle takes place after ovulation. In the luteal phase, LH stimulates the follicular tissue within the ovary to transform into a glandular structure called the corpus luteum.
- The corpus luteum secretes progesterone and estradiol, which then exert negative-feedback on the hypothalamus and pituitary. This feedback reduces LH and FSH secretion to very low levels and thereby prevents the maturation of another egg in the ovary.
- If there is no pregnancy, the low gonadotropin levels at the end of luteal phase promotes disintegration of the corpus luteum.
- Disintegration of corpus luteum leads to the sharp decline in hormones. As a result the negative-feedback of estradiol and progesterone on the hypothalamus and pituitary are removed. This enables the pituitary to produce FSH to stimulate the growth of a new follicles thereby starting the next ovarian cycle.

2. Uterine (menstrual) cycle

Uterine cycle consists of proliferative phase, secretory phase and menstrual flow phase.

- Proliferative phase: Before ovulation, steroid hormones of the ovary stimulate the uterus to prepare for support of an embryo. Growing follicles secrete estradiol that stimulates the endometrium to thicken. This is referred to as the proliferative phase in the uterine cycle. Therefore the follicular phase of the ovarian cycle coordinates with the proliferative phase of the uterine cycle.
- The secretory phase starts after ovulation. After ovulation, estradiol and progesterone that are secreted from the corpus luteum stimulate the maintenance and further development of the lining of the uterus by enlarging the arteries and growth of the endometrial glands.

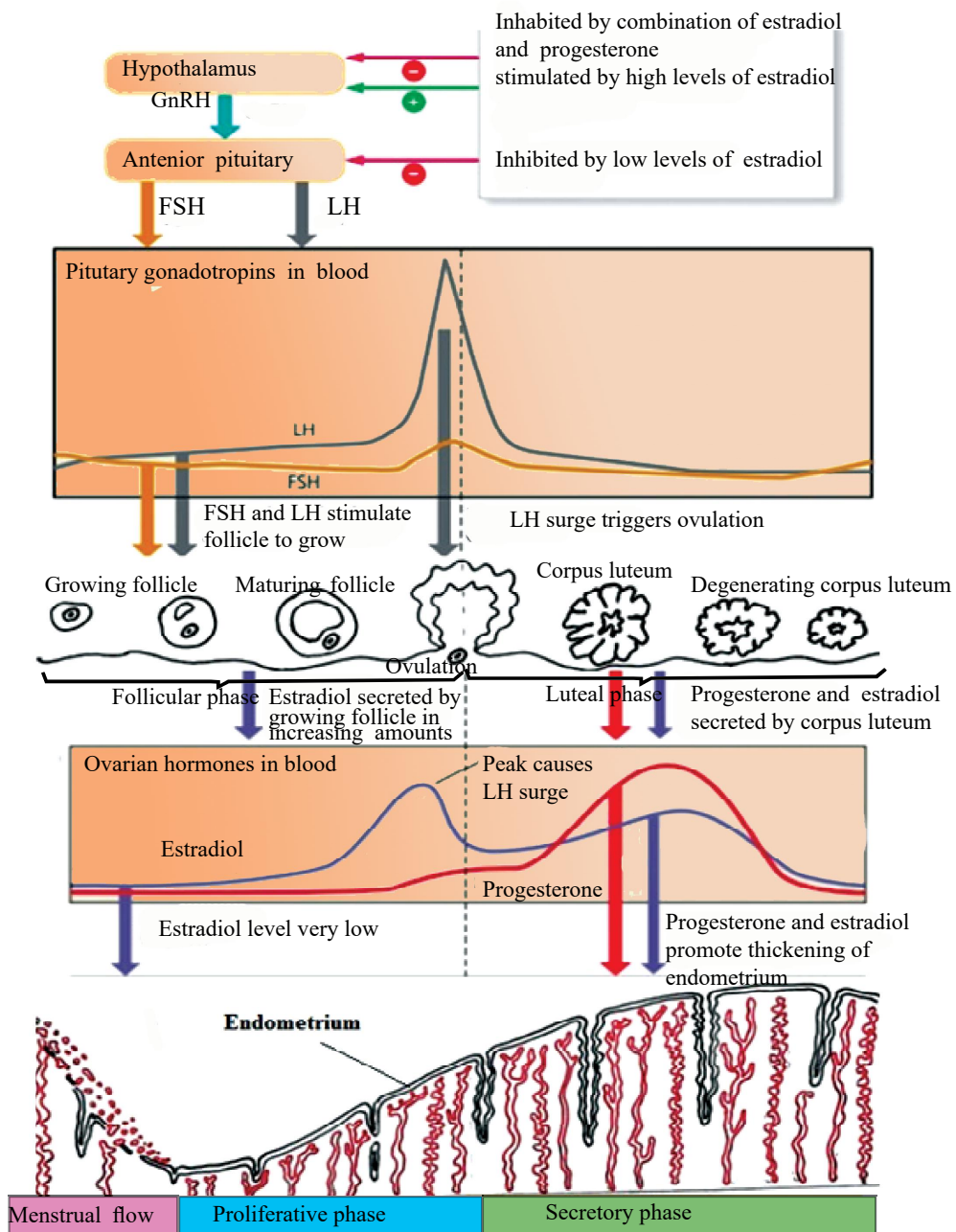

Figure 5.29: The reproductive cycles of human female showing how ovarian cycle and uterine cycle are regulated by changing hormone levels in the blood.

These glands secrete nutrient fluid that can sustain an early embryo if fertilization occurs. Hence, the luteal phase of the ovarian cycle is coordinated with the secretory phase of the uterine cycle.

- **Menstrual flow phase:** If implantation of an embryo does not occur, the corpus luteum disintegrates which results in the drop in ovarian hormones. This brings about the end of the secretory phase. As a result, arteries constrict and thereby the uterine lining disintegrates and causes the shedding of endometrial tissues and fluid. This is the menstrual flow phase of the uterine cycle. The cyclic shedding of the blood-rich endometrium from the uterus, a process that occurs in a flow and which lasts for a few days through the cervix and vagina is called menstruation.

Menopause

This is the cessation of ovulation and menstruation in a woman. Usually menopause takes place between the ages of 45 and 55 years. During this time the ovarian supply of oocytes runs out and the estrogen production by the ovary decreases. Ovaries become less responsive to the hormones FSH and LH produced by the anterior pituitary.

Human Development

Growth of a new human being starts when an ovum is fertilized by a sperm usually in the oviduct. During the development of the individual within the mother's uterus, a sequence of events occurs from fertilization to the birth which normally ends in 38 weeks or roughly 9 months. The first 8 weeks of human development is called the embryonic period and thereafter the developing individual is called a fetus.

- **Fertilization/conception and the formation of a human zygote**
During ovulation a secondary oocyte arrested at metaphase II enters the oviduct. During fertilization a sperm enters the secondary oocyte penetrating the epithelial cells surrounding the oocyte, the glycoprotein layer present between the oocyte's plasma membrane and the surrounding cells. Once the sperm enters the secondary oocyte, meiosis II of the oocyte is completed producing the mature ovum. Subsequently, the two haploid pronuclei of the mature ovum and the sperm fuse to produce a diploid, single cell referred to as the zygote. The fusion of the haploid nuclei of the sperm and the ovum is called fertilization. Fertilization takes place in the upper reaches of the oviduct within 12 to 24 hours after ovulation.
- **Cleavage of the zygote, blastocyst formation and implantation**
About 24 hours after fertilization, a series of rapid mitotic cell divisions called 'cleavage' take place in the zygote. Cleavage of zygote begins in the oviduct as it moves forward towards the uterus by ciliary and peristaltic movements. Cleavage continues forming a

solid ball of cells (morula) by the time the embryo reaches the uterus (about 3-4 days after fertilization).

Morula floats within the uterine cavity and gets nutrition by endometrial secretions. About five days after fertilization, a large fluid filled cavity is formed surrounding the ball of cells. With the formation of the cavity, this developing stage is referred to as the blastocyst. Further rearrangements of the cells in the blastocyst results in two distinct structures: the inner cell mass and the trophoblast. Inner cell mass is located internally and eventually develops into the embryo and the membranes enclosing the embryo are called the amniotic sac. The trophoblast which is the outer layer of cells will ultimately develops into the fetal portion of the placenta.

Around 7 days after fertilization, the blastocyst attaches to the endometrium of the mother's uterus. This is called implantation. As the blastocyst implants, the inner cell mass orients towards the endometrium. The trophoblast grows outward and invades the endometrium. This is initiated by the enzyme secreted by the trophoblast to breakdown the uterine lining. Then the trophoblast extends finger like projections into the endometrium. Trophoblast begins to secrete human chorionic gonadotropin (hCG) hormone which has the action similar to LH. The hormone hCG rescues the corpus luteum from degeneration and sustains its secretion of progesterone and estrogen which maintain the uterine lining preventing menstruation.

After implantation, three germ layers are formed in the developing embryo at the end of the gastrulation stage. Extra-embryonic membranes begin to appear which surround the embryo. The placenta is formed by the cells of trophoblast and the adjacent endometrial tissues.

- **Embryonic members / fetal membranes**

Four new extra embryonic membranes appear after implantation. They are chorion, amnion, yolk sac and allantois. They provide a life support system for further embryonic/fetal development.

Chorion becomes the main embryonic portion of the placenta which is the structure for exchange of materials between the fetus and mother. It also protects the embryo/fetus from immune responses of the mother. Chorion produces hCG, an important hormone of pregnancy.

Amnion is a protective membrane surrounding the embryo/fetus creating a fluid filled cavity which serves as a shock absorber and helps prevent desiccation.

Yolk sac contributes to the cells that will become blood cells until the fetal liver takes over. It also is the source of primordial germ cells that migrate to the developing gonads.

Allantois is a small outer-pouching of the yolk sac that serves as an early site for blood formation and is associated with the development of the urinary bladder.

- **Placenta and umbilical cord**

During the first 2-4 weeks of embryonic development, the embryo obtains nourishment directly from the endometrium. Eventually, the embryonic trophoblast and the mother's endometrium intermingles and form the placenta. The placenta is a disc shaped organ formed by two parts: embryonic/fetal portion formed by chorionic villi of the chorion and maternal portion formed by the endometrium. The placenta contains both embryonic/fetal and maternal blood vessels. However maternal and fetal blood vessels do not join and the blood they carry do not normally mix. The placenta mediates the exchange of material (nutrients, respiratory gases, metabolic wastes) between the embryonic/fetal and the mother's circulatory systems. The placenta supplies oxygen and nutrients to the fetus from the maternal blood stream and excrete waste products from the fetus to the maternal blood stream. The placenta also helps to provide immune protection to the developing embryo/fetus. The placenta produces hormones (e.g. hCG, progesterone etc.) needed to sustain the pregnancy.

Umbilical cord is a flexible cord-like structure containing blood vessels and attaches embryo/fetus to the placenta during gestation. Oxygen poor blood from the embryo/fetus travels to the placenta through the two arteries of the umbilical cord and passes through fingerlike projections (chorionic villi) of the placenta where oxygen and nutrients are acquired. Fetal blood (oxygen rich blood) leaves the placenta through the umbilical vein leading back to the embryo/fetus.

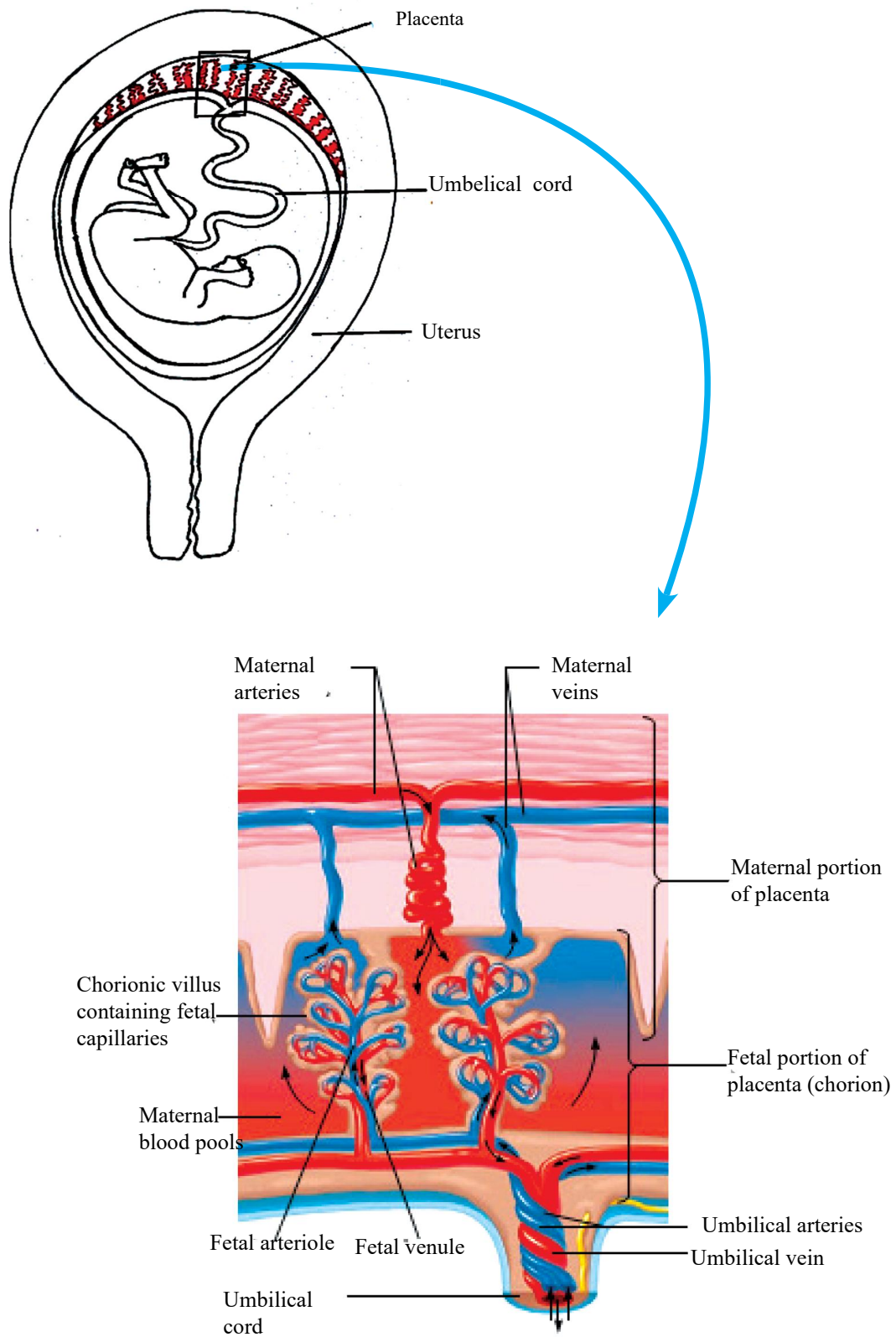

Figure 5.30: Placenta and umbilical cord

Pregnancy and its duration

Pregnancy or gestation is the condition of carrying one or more developing offspring inside the uterus of a female. Human pregnancy period is usually 38 weeks from fertilization to birth or roughly 9 months (or 40 weeks from the last menstruation to birth). The nine months of pregnancy are divided into three trimesters of about three months each.

During the first trimester, the implanted embryo secretes hormones to regulate the mother's reproductive system and to indicate its presence. The hCG hormone secreted by the embryo, maintains the corpus luteum in the ovary to secrete progesterone and estrogen. Some amount of this hCG passes from the maternal blood to the urine. The presence of hCG in pregnant mother's blood and urine can be easily detected and therefore is used as an early pregnancy detection test. High levels of progesterone brings about rapid changes in the mother. Both ovulation and menstrual cycles stop, the maternal side of the placenta grows, and the breasts and the uterus get larger. Mucus in the cervix of the mother forms a plug which prevents the fetus from infections. Most mothers experience nausea (morning sickness) during the first trimester.

By the second trimester, the level of hCG declines and as a result the corpus luteum deteriorates. But the placenta takes over the production of progesterone and estrogens which helps to maintain the pregnancy. Mother can feel fetal movements. As the fetus grows, mother's abdominal organs become compressed and displaced. In the third trimester of pregnancy this may lead to digestive blockage and frequent urination.

Major fetal changes in each trimester

- **First trimester**

The first trimester is the most critical stage of development during which the rudiments of all major organ systems appear. This is the main period of organogenesis (the development of the body organs). The heart begins to beat by the 4th week (can be detected at 8-10 weeks). By the 8th week, embryo is said to be the fetus as all the parts of an adult are present in rudimentary form. At the end of the 1st trimester, the fetus is well differentiated and about 5 -7 cm long.

- **Second trimester**

By the end of second trimester, the fetus assumes distinctively human features. Organ systems are completely developed in this stage. During the second trimester, the fetus grows to about 30 cm in length and is very active so that the mother may feel the fetal movements.

- **Third trimester**

The third trimester represents a period of rapid fetal growth. During the early stage of this period, most of the organ systems become fully functional. During the third trimester, the fetus grows to about 50 cm in length and weighs about 3-4 kg. Fetal activity decrease as it fills the space within the uterus.

Maternal immune tolerances of the embryo and fetus

During pregnancy the overall regulation of the mother's immune system changes. These changes allow the mother to keep the embryo in her uterus without rejecting as a foreign body even though half the embryo's genes are inherited from the father and many chemical markers on the surface of the embryo are foreign to the mother.

Process of parturition

Child birth begins with the labor. The labor is a series of strong, rhythmic uterine contractions that push the fetus and placenta out of the body. When labor begins, local regulators (prostaglandins) and hormones (mainly estradiol and oxytocin) induce and regulate further contractions of the uterus. This is a positive feedback mechanism as uterine contractions stimulate secretion of oxytocin which stimulates further contractions of the uterus.

The labor can be divided into three stages. The first stage is the thinning and opening up (dilation) of the cervix. The second stage is the delivery of the baby. In this stage, continuous and strong contractions force the fetus out of the uterus and expell through the vagina. Delivery of the placenta is the final stage of labor.

Lactation

The lactation which is unique to mammals begins as post natal care. Lactation is the secretion and ejection of mother's milk from the mammary glands. Lactation is subjected to nervous and hormonal regulation. The main hormone in promoting milk synthesis and secretion is prolactin. In response to suckling by the new born baby (which initiates nerve impulses from touch receptors in the nipples) and decrease in estradiol and progesterone levels in the mother's blood after birth, the hypothalamus send impulses to the anterior pituitary to secrete prolactin hormone which stimulates the mammary glands to produce milk. Suckling also stimulates the secretion of oxytocin hormone from the posterior pituitary gland and triggers the release (ejection) of milk from the mammary glands. This is a positive feedback mechanism as milk availability encourages continuous suckling, so touch sensation on the nipple and oxytocin release continue further ejecting milk from the mammary glands.

Composition of human milk and significance of breast feeding

During the first few days after birth, the mammary glands secrete a fluid called ‘colostrum’ until appearance of true milk. Human milk is a sterile solution that contain nutrients such as lactose, fatty acids, amino acids, minerals, vitamins, and water that are ideal for baby’s digestion, brain development and growth. Human milk includes proteins such as casein, lactalbumin and immunoglobulins.

Colostrum and true milk provide nutrients for the baby and contain important antibodies that protect the infant. Several types of white blood cells are also present in the breast milk which help the baby to resist microbial infections. Compared to the true milk, colostrum contains less nutrients (less lactose and no fat) but they are adequate for the early nutritional needs.

Breast feeding supports optimal infant growth, enhances intellectual development and fosters mother-infant relations by establishing early and prolonged contact between them. Compared to cow’s milk, the fat, iron and the proteins in the breast milk are more readily metabolized. Lower sodium content of breast milk is more suited to the baby’s needs. The baby is less likely to have allergic reactions to mother’s milk than the milk from another source.

Birth control methods

The deliberate prevention of pregnancy is called contraception. This can be achieved in several ways. Some contraceptive methods prevent gamete development or releasing gametes. Some contraceptive methods prevent fertilization of gametes. Some methods are available to prevent implantation of an embryo. Unwanted pregnancies are avoided by birth control methods.

Common temporary birth control methods:

- Oral contraceptives for females: Most oral contraceptives contain high concentration of synthetic estrogen and progesterone. High levels of these hormone inhibit GnRH release from hypothalamus and FSH and LH secretions from anterior pituitary through negative feedback. Prevention of LH release blocks ovulation. Inhibition of FSH secretion prevents follicle maturation. Some oral contraceptives contain only high levels of synthetic progesterone (progestin) which thickens cervical mucus so that it blocks entering sperms to the uterus. If fertilization occurs it can interfere with implantation as well.
- Condoms for males: Barrier devices which prevent sperm entry
- IUD (loop) for females: A device placed in the uterus which interferes with fertilization and prevents implantation of a fertilized ovum
- Depo-Provera injection for females: Periodic injection of a synthetic progesterone which thicken cervical mucus and prevents sperm entry. If fertilization occurs it prevents implantation by making the endometrium thin.

Surgical Sterilization (preventive methods of gamete release)

- Vasectomy for males- Prevents release of sperms
- Tubal ligation for females- Prevents ovum from entering uterus

Abortion

- Abortion is the premature termination of a pregnancy in progress.
- Miscarriage: Spontaneous abortion which occurs naturally.
- Induced abortion is intentionally performed (surgical or nonsurgical). Certain drugs can induce abortion non-surgically within the first 7 weeks after conception. They block progesterone receptors in the uterus thereby preventing progesterone from maintaining the pregnancy.

Table 5.6: Sexually transmitted infections

Infection	Pathogen	Main mode of transmission	Main symptoms
Gonorrhoea	<i>Neisseria gonorrhoeae</i> bacterium	<ul style="list-style-type: none"> • Sexual contact, • Mother to child at birth 	In males-burning feeling/discomfort when passing urine, yellow discharge with pus from genito-urinary tract.
Syphilis	<i>Treponema pallidum</i> bacterium	<ul style="list-style-type: none"> • Sexual contact, • Mother to child at birth 	Accompanied by fever, headache.
AIDS (acquired immunodeficiency syndrome)	HIV(Human immunodeficiency virus)	<ul style="list-style-type: none"> • Sexual contact • Transfer of body fluids (blood, serum) • Use of unsterilized needles • Mother to fetus/child :during pregnancy, at birth and during lactation 	Sores or painless ulcers on any part of the body (vagina, lips, fingers, nipples), fever, skin rashes Loss of appetite and weight, fever, persistent dry cough, Lymphoma (cancer in lymphatic system), pneumonia and other disease resulting from breakdown of the immune system
Genital herpes	Herpes simplex 2 virus	Sexual contact	Itchy, painful sores around genital area, fever in some cases

Detecting disorders during pregnancy

- Many development problems and genetic disorders can be diagnosed during the gestation period.
- Ultrasound images can be used to analyze the size and condition of the fetus.
- Amniocentesis and chorionic villi sampling –a needle is used to obtain fetal cells from amniotic fluid or tissue surrounding the embryo. Genetic analysis can be done with these samples.
- Newest method is to use a pregnant mother's blood to analyze the genome of the fetus as the mother's blood contains fetal DNA
- But all detectable disorders are untreatable when the embryo is in the uterus and many cannot be corrected even after birth. However, parents can take informed decisions with the help of these tests.

Infertility

Infertility is the inability to conceive offspring. Both men and women can have reproductive defects leading to infertility. The number of couples facing this problem appears to be increasing in the modern society. Certain forms of infertility are treatable.

Modern reproductive technology for resolving infertility problems

- Some infertility problems are resolved by recent scientific and technological advances. This includes hormone therapy, surgery and assisted reproductive technology.
- Hormone therapy– Sometimes, hormone therapy can increase sperm production in the infertile male or egg production in the infertile female.
- Surgery: The ducts in the reproductive system that are formed improperly or have become blocked can be corrected surgically to resolve infertility.
- Assisted reproductive technology

In vitro fertilization (IVF): In vitro fertilization is a series of procedures used to treat infertility problems and assist with the conception of a child. The process involves removal of oocyte(s) from a female ovary and obtaining sperm from a male and combining the oocyte and the sperm to achieve the fertilization under laboratory conditions. The fertilized eggs are incubated until they reach at least 8 cells and then these embryos are transferred to the woman's uterus for implantation and to continue its development. Conventional IVF needs between 50 and 100 thousands of sperm from the male per one oocyte in order to achieve the fertilization. This is due to the fact that in IVF, acrosome reaction has to take place and thousands of sperm cells have to be involved.

Intra-cytoplasmic sperm injection (ICSI): This is also a type of in vitro fertilization method which is used to address male infertility. If mature sperm are defective or low in number, a whole sperm or a spermatid nucleus is injected directly into the cytoplasm of an oocyte that has been removed from the women's ovary. For insemination, ICSI needs only one sperm per oocyte. Unlike in conventional IVF, the sperm which will be inserted into a particular oocyte is already selected in ICSI. The fertilized egg can then be returned to the woman's uterus for implantation.

Support and Movement

The structure and functions of the skeletal systems of animals

In the animal kingdom, three major types of skeletons are found. They are hydrostatic skeletons, exoskeletons and endoskeletons.

Hydrostatic skeleton is a fluid filled body cavity which is enclosed by the body wall. In cnidarians, gastrovascular cavity acts as the hydrostatic skeleton. In some animals such as nematodes and annelids, the fluid filled cavity enclosed by the body wall (e.g., pseudocoelom in Nematoda, coelom in Annelida) consists of two muscle layers (longitudinal and circular muscles) which act antagonistically. The combined effect of muscle contraction and fluid pressure aids in locomotion and maintain the shape and form of the animal. In many animals, the spaces between cells are filled with fluid called interstitial fluid which provides support to these cells.

Exoskeleton is a rigid outer covering of the body of the animal which acts as a skeleton. Different types of exoskeletons are seen in the animal kingdom: Chitinous exoskeleton, calcium carbonate exoskeleton and bony plates. Arthropods possess the exoskeleton which is mainly composed of a non-cellular material, chitin. The chitinous exoskeleton is hardened by proteins or calcium carbonate. Exoskeletons that are made up of calcium carbonate are seen in the molluscs. In some reptiles, bony plates serve as the exoskeleton.

Endoskeleton is a hard skeleton which is buried in the soft tissues of the animal. Different types of endoskeletons are seen in the animal kingdom. These include plates of calcium carbonate (in echinodermites), bones and cartilage (in chordates).

Common functions of the skeletal systems in animals

- Support – All skeletons provide a rigid framework for the body and are resistant to compression and tension forces. They help to maintain the shape of body.
- Protection – The skeleton protects the delicate internal organs.
- Movement – Most skeletons are composed of rigid materials which provide a means of attachment for the muscles of the body. Parts of the skeleton operate as levers on which the muscles can pull. When this occurs, movement takes place.

Functions of the human skeletal systems

- Support
- Protection
- Movement

- Storage and release of calcium under the influence of some hormones (refer competency level 5.7.1)
- Storage and release of phosphates under the influence of some hormones (refer competency level 5.7.1)
- Production of blood cells in the bone marrow

How animals move through water and air?

Swimming: Different groups of animals swim in different ways. Some animals use their legs as oars to push against the water (e.g. insects and four legged vertebrates). Some animals are jet propelled taking water into the body and squirting it out in bursts (e.g. squids). Fishes swim by moving their body and tail from side to side. Aquatic mammals move by undulating their body and tail up and down (e.g. whales and dolphins). Fusiform body shape is a common adaptation for fast swimming animals.

Movement through air: Animals move through air mostly by flying. Gliding downward can occur in some instances. Flying animals use wings to lift the body against the gravity. Wings act as air foil: their shapes alter air currents in a way that helps flying. Fusiform shape of the wings helps to reduce drag force in air.

The human skeleton

Human skeleton is divided into two main parts: axial skeleton and appendicular skeleton.

- Axial skeleton consists of skull, vertebral column, sternum and ribs.
- Appendicular skeleton consists of girdles (pectoral and pelvic) and limb bones.

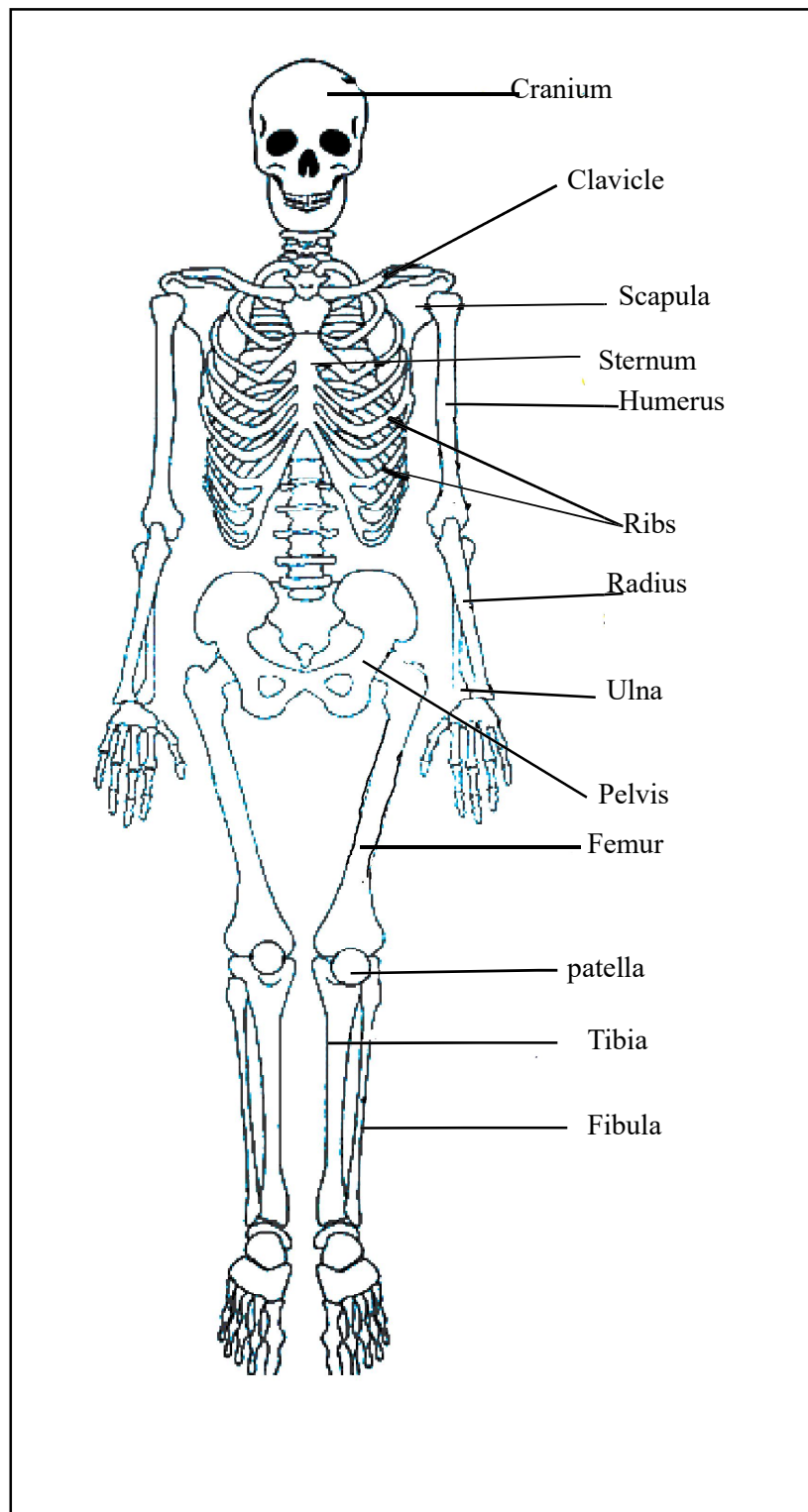

Figure 5.31: The anterior view of the human skeleton

Organization of the human axial skeletal system

Skull

In humans, the skull rests on the upper end of the vertebral column. The human skull consists of 21 bones which are mostly connected together by ossified joints (sutures). Skull is divided into the cranium (brain case) and the face. The bones in the cranium are the frontal bone, two parietal bones, the occipital bone, two temporal bones, the ethmoid bone and the sphenoid bone. In addition to the frontal bone, thirteen other bones form the skeleton of the face. They are two zygomatic bones (cheek), the maxilla (upper jaw bone), two nasal bones, two lacrimal bones, the vomer, two palatine bones, two inferior conchae and the mandible (lower jaw bone).

Human cranial capacity is nearly 1.5 L. Cranium protects and encloses the brain. It also protects the inner ear, middle ear, olfactory organs and eyes. Bony eye sockets provide attachment to the eye muscles that move them. On the inferior surface of the cranium there is foramen magnum to provide passage to spinal cord. Two smooth rounded knobs (Occipital condyles) on either side of the foramen magnum articulates with the first vertebrae (atlas vertebrae) which permits nodding movements.

In the cranium, soft membranous regions called fontanelles are present which allow slight compressions at birth facilitating parturition. Fontanelles become replaced by bones within 1-2 years of life. Immovable joints (sutures) are present between the skull bones to provide more protection. Several air filled cavities lined by ciliated mucous membrane are present in the skull (in the sphenoid, ethmoid, maxillary and frontal bones). They are called sinuses. They all communicate with the nasal cavity. Sinuses provide resonance to voice and reduce the weight of the skull.

Facial region is situated below the cranium. Some facial bones form the walls of the posterior part of the nasal cavity and form the upper part of the air passages. Maxilla and mandible provide ridges in which teeth are embedded. Upper jaw (maxilla) is fused with cranium. Lower jaw (mandible) is movable. Hard palate (bony) and soft palate (cartilaginous) separate the buccal cavity from nasal cavity. Lower jaw articulates with the cranium. Zygomatic arch (formed from parts of zygomatic bone and temporal bone) provides the surface for muscular attachment for moving the lower jaw. Lower jaw (mandible) contains two processes: Condylod process which articulates with the temporal bone to form the temporal-mandibular joint; Coronoid process which gives attachment to muscles and the ligaments. At the base of the skull, occipital condyles (1 pair) are present on the two occipital bones to form a hinge joint with atlas vertebrae. Temporal bone contains three processes: zygomatic process (which forms part of the zygomatic arch), mastoid process and styloid process. They provide surfaces for muscle attachment.

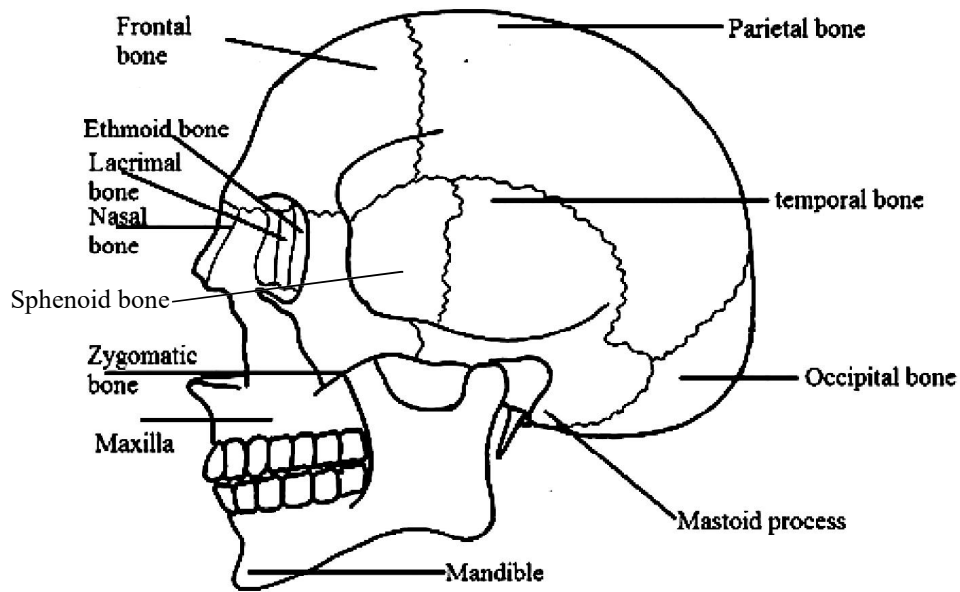

Figure 5.32: The bones of the human skull

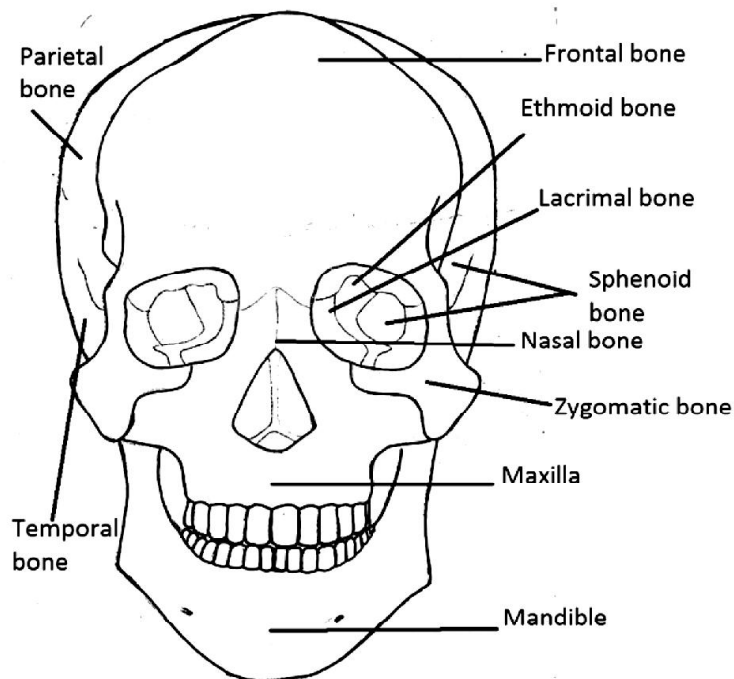

Figure 5.33: The anterior view of the human face (bones in the face)

Vertebral column

Vertebral column is a strong flexible rod consisting of 26 linearly arranged bones. It consists of 24 separate vertebrae extending downwards from the occipital bone of the skull, the sacrum (formed from 5 fused vertebrae) and coccyx (formed from 4 small fused vertebrae). The vertebral column is divided into different regions. There are 4 distinct regions: cervical spine (formed by 7 vertebrae in the neck), thoracic spine (formed by next 12 vertebrae), lumbar spine (formed by next 5 vertebrae), and the sacrum to which the lowest vertebrae of lumbar spine is articulated; the coccyx is situated at the end.

Curvatures of the vertebral column

In humans, there are four curves in the vertebral column: cervical, thoracic, lumbar and sacral. They can be categorized into two main types: two primary curvatures and two secondary curvatures. Main function of the curvatures is the maintenance of the erect posture.

Primary curvatures: In the foetus, there is only one curvature in the vertebral column. When secondary curvatures are formed the primary curvature is retained only in thoracic and sacral regions which are known as primary curvatures. They are concave anteriorly.

Secondary curvatures: Formed after birth, first cervical curvature develops at about 03 months of birth. Then the child can hold his head upright. Second, lumbar curvature develops when the child is around 7-8 months. Then the child can hold his body upright. These secondary curvatures are convex towards the anterior.

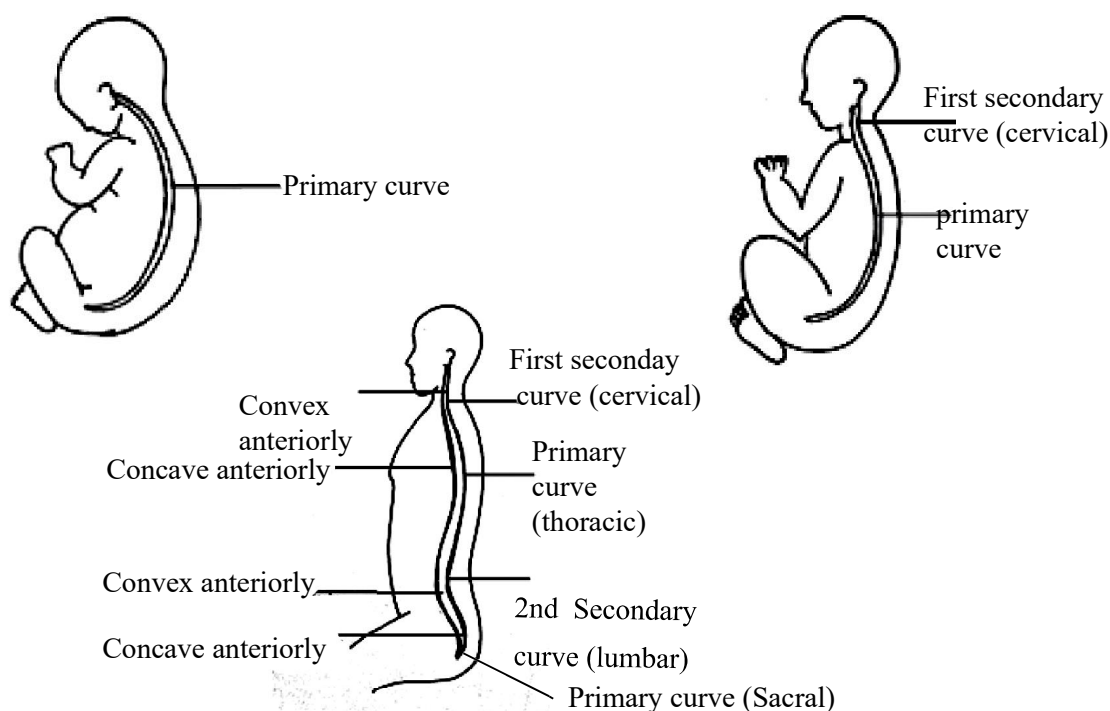

Figure 5.34: The development of curves in the human vertebral column

Types of vertebrae

Structure of a typical vertebra

A lumbar vertebra can be considered a typical vertebra. A typical vertebra consists of the body and the vertebral arch. The body is the largest, broad and flattened part of the vertebrae. The flattened surface of the body of each vertebra articulates with the corresponding surface of the adjacent vertebra so that vertebrae are stacked together in the vertebral column. However the adjacent two vertebrae are not in direct contact with each other as there is a tough pad of cartilage called intervertebral disc between the two vertebrae. The size of the body of the vertebra increases downwards of the vertebral column to support the body weight.

Vertebral arch encloses vertebral foramen which provides passage way for the spinal cord. Processes arising from the neural arch provide surfaces for muscle attachment. Two lateral processes are called transverse processes and the posterior process is called spinous process. The vertebral arch has four articular surfaces: two superior articular surfaces (articulate with the adjacent vertebrae above) and two inferior articular surfaces (articulate with the adjacent vertebrae below).

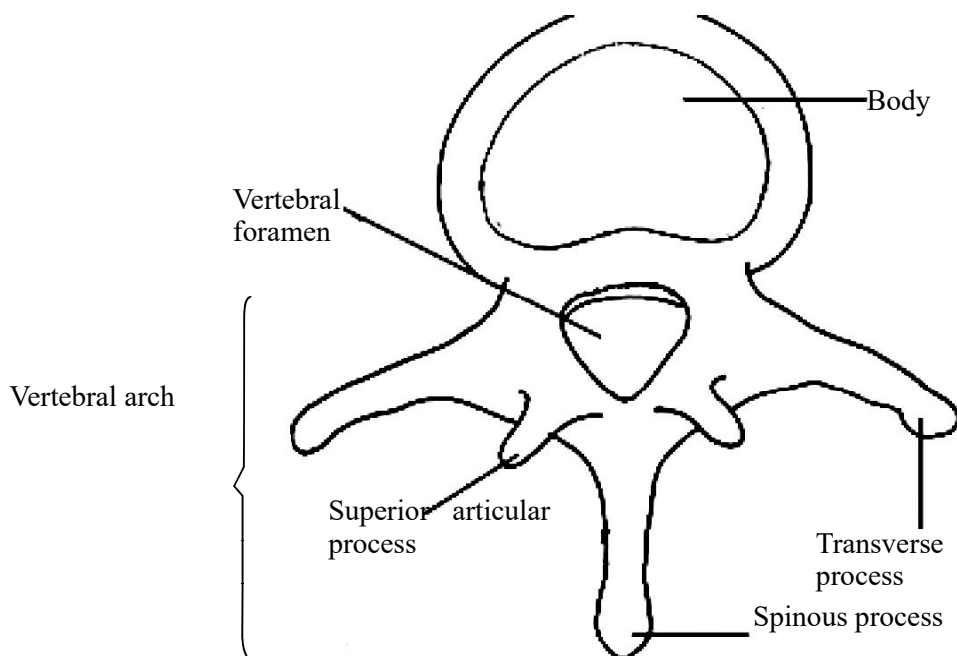

Figure 5.35: The structure of a typical vertebra (lumbar vertebra)

Region specific vertebral characteristics

Cervical vertebrae: Cervical vertebrae are the first seven vertebrae in the vertebral column. When compared to the other types of vertebra, cervical vertebrae are the smallest. Body of the cervical vertebra is smaller compared to the other vertebrae. In addition, transverse processes of a cervical vertebra have a foramen on each side to provide passage for the vertebral artery. The spinous process of these vertebrae is bifid.

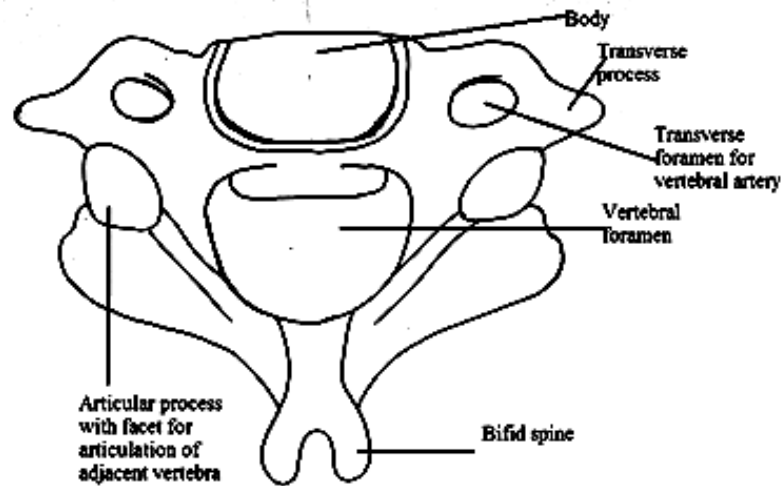

Figure 5.36: The structure of the typical cervical vertebra

The first cervical vertebra is the atlas which is the bone on which the skull rests. It is a ring shaped vertebra with no distinct body or spinous processes. It has two short transverse processes. The atlas contains two flattened facets which articulate with the occipital bone of the skull (condyloid joints), permitting nodding movements. Vertebral foramen of this vertebra is relatively larger to provide the passage of the larger anterior part of the spinal cord.

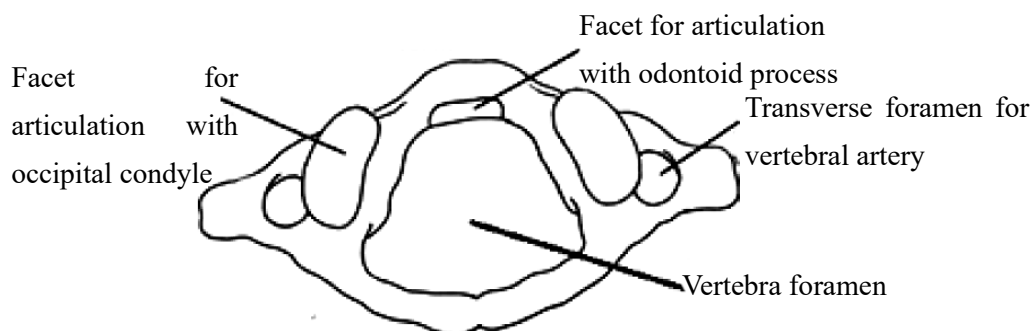

Figure 5.37: The structure of the atlas vertebra

The second cervical vertebra is the axis. It has a small body with a superior projections called odontoid process which articulates with the atlas vertebra above. The head pivots (turns on side to side) on this joint.

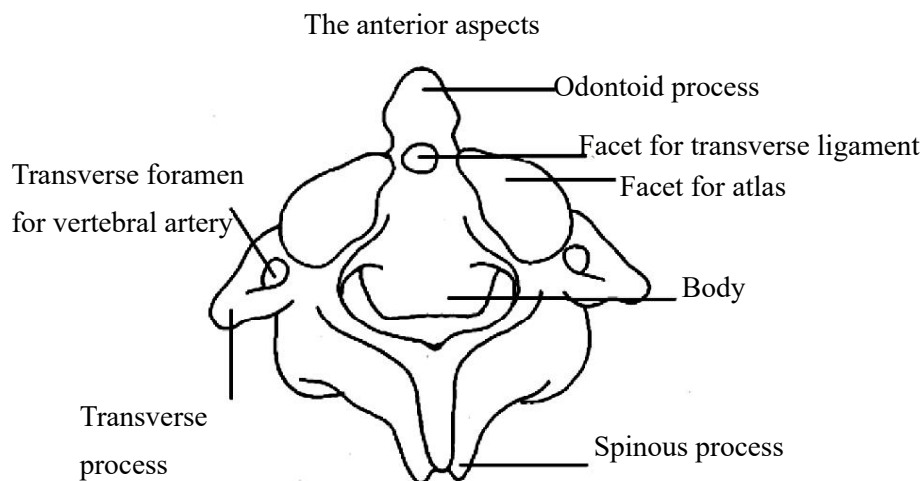

Figure 5.38: The structure of the axis vertebra

Thoracic vertebra: The twelve thoracic vertebrae are larger than cervical vertebrae as this region of the vertebral column has to support more body weight. The body and transverse processes of thoracic vertebrae have facets for articulation with the ribs

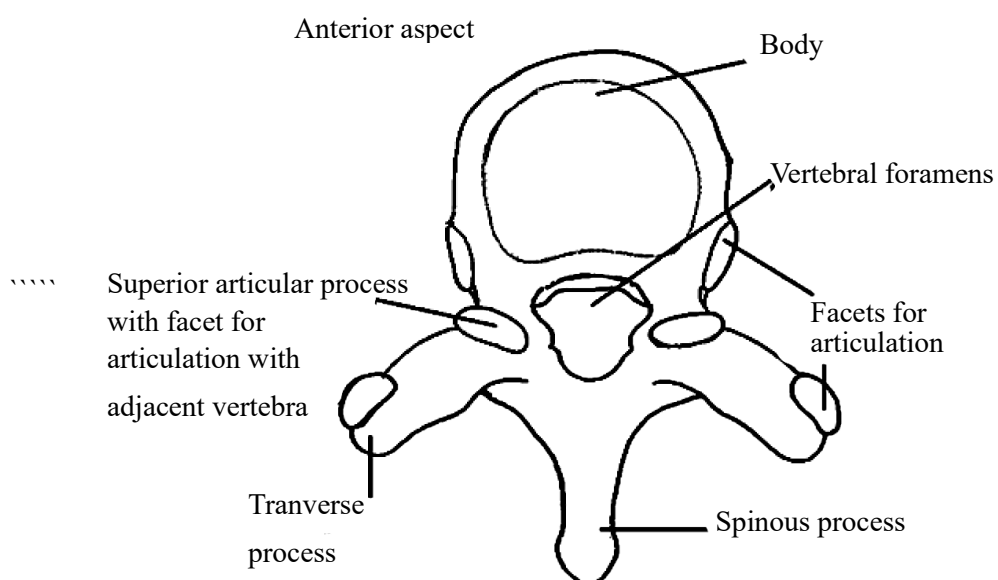

Figure 5.39 : The structure of thoracic vertebra

Lumbar vertebrae: The five lumbar vertebrae are the largest of the vertebrae because they have to support the weight of the upper body. The size of the body of the lumbar vertebrae is larger compared to the other vertebrae. For attachment of the muscles of lower back, the lumbar vertebrae have relatively large spinal processes.

Sacrum and Coccyx: Sacrum is a triangular shaped large bone consisting of five fused rudimentary vertebrae. It has a concave anterior surface. The upper part articulates with the fifth lumbar vertebrae. On each side, sacrum articulates with the pelvic girdle. Inferior tip of the sacrum articulates with coccyx. A series of vertebral foramina are present on each side for passage of nerves. Coccyx consists of fused four terminal vertebrae to form a small triangular bone. The broad base of the coccyx articulates with the tip of the sacrum.

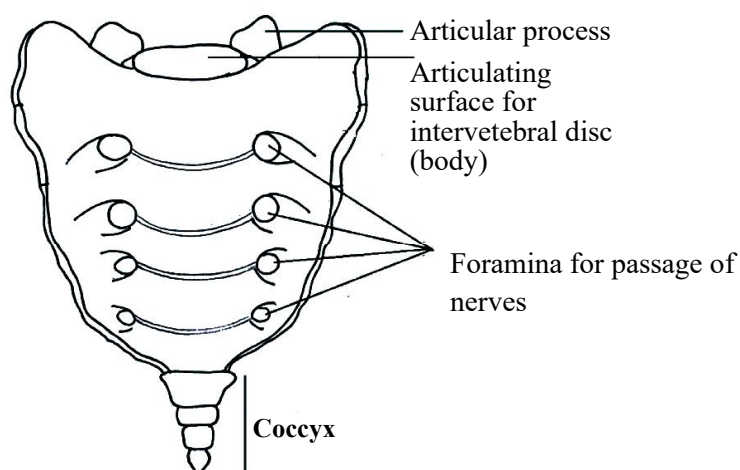

Figure 5.40: The anterior view of the sacrum and coccyx

Common functions of the human vertebral column

The vertebral column helps to maintain the erect posture. It supports the skull and gives attachment to ribs and girdles. It also provides the protection for the spinal cord. Vertebral foramina provide spaces for spinal nerves and blood vessels and lymph vessels. The vertebral column allows flexibility in the body movements. The intervertebral discs act as shock absorbers and protect the spinal cord.

Sternum

Sternum is a long flat bone that forms anterior part of the thoracic cage (which is made up of sternum, ribs and thoracic vertebrae). The uppermost section of the sternum is the manubrium which articulates with the clavicles in the pectoral girdles and the first two pairs of ribs. The body, which is the middle part of the sternum gives attachment to the rest of the ribs. The xiphoid process is the tip of the bone which gives attachment to the diaphragm and muscles of the anterior

abdominal wall. The sternum provides protection to the organs and blood vessels that lie behind it (heart and lungs) from physical damage. The red bone marrow in the sternum is one of the main sites for production of blood cells.

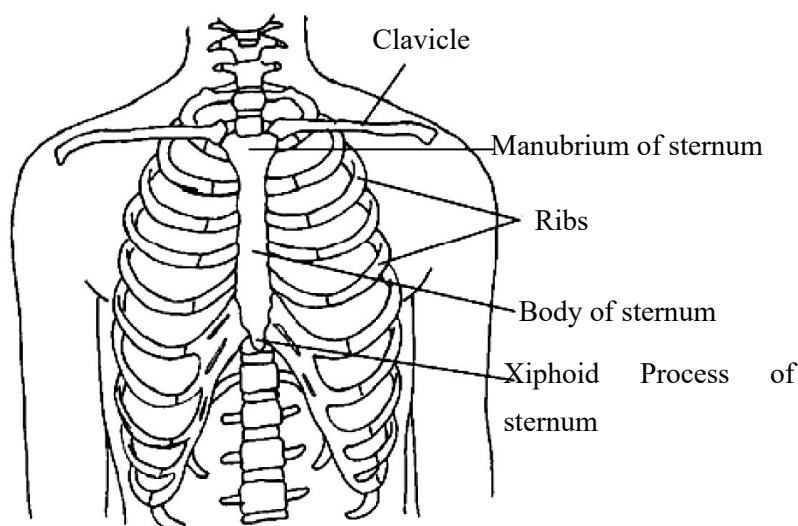

Figure 5.41: The thoracic cage and the location of the sternum

Ribs

The twelve pairs of ribs form the lateral walls of the thoracic cage. They are elongated curved bones. They articulate posteriorly with the thoracic vertebrae of the vertebral column. Anteriorly 7 pairs of ribs articulate with the sternum (true ribs), next 3 pairs articulate with sternum indirectly. In both cases costal cartilages attach the ribs to the sternum. The lowest 2 pairs do not join the sternum (floating ribs). Head of the rib articulates with vertebral bodies, facets of tubercle articulate with transverse process of vertebrae. The thoracic cage which includes the ribs and sternum plays an important role in the mechanism of breathing. Between each ribs intercostal muscles are present which move the rib cage during breathing. The first rib is firmly fixed to the sternum and to the first thoracic vertebra. Therefore it does not move during inspiration. Because it is a fixed point when the intercostal muscle contract they pull the entire rib cage upwards and towards the first ribs. Presence of 12 pairs of ribs and sternum provides protection to the organs such as lungs and heart in the thoracic cavity.

Contribution of human axial skeleton to maintain the upright posture

- Presence of two primary curvatures and two secondary curvatures in the vertebral column. Development of the two secondary curvatures in the vertebral column mainly contribute to maintain the erect posture. (Refer the section on curvatures of vertebral column).

- The size of the vertebrae (especially the body of the vertebrae) become larger towards the end of the vertebral column as they have to support the weight of the upper body (Refer the section on vertebrae).
- The sacral vertebrae are fused to form a triangular shaped large sacrum to support the weight of the vertebral column and internal organs of the body.
- The two occipital condyles (and the foramen magnum) are located inferiorly at the base of the skull close to the center. In the upright position, this arrangement permits proper balancing of the skull on the vertebral column.

The structure and functions of the human appendicular skeleton

Appendicular skeleton

The appendicular skeleton consists of upper limbs with pectoral (shoulder) girdle and lower limbs with the pelvic girdle. Through the pectoral girdle the upper limb forms the joints with the trunk. Pectoral girdle connects upper limb with the axial skeleton. Pectoral girdle consists of two scapulae (shoulder blades) and two clavicles (collar bones). The lower limb forms a joint with the trunk at the pelvic girdle. Pelvic girdle is formed from two hip bones and it is associated with the sacrum.

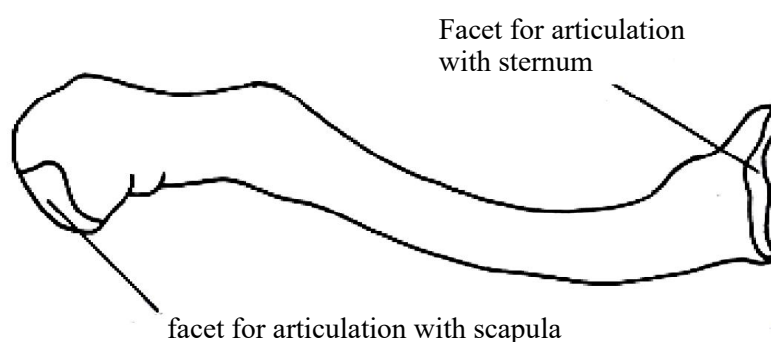

Figure:5.37 -The right clavicle

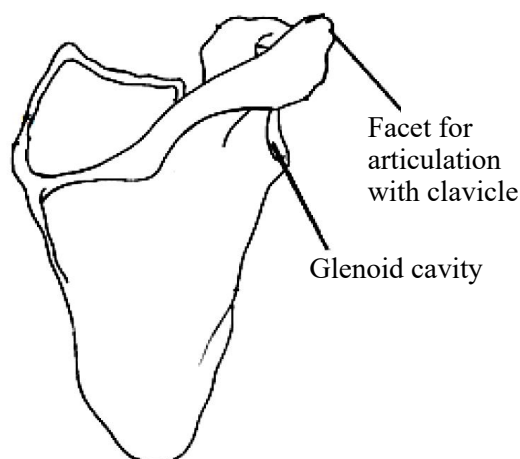

Figure 5.42: The right scapula

Upper limb

Upper limb consists of humerus, radius, ulna, eight carpal bones, five metacarpal bones and fourteen phalanges. Humerus is the bone of the upper arm.

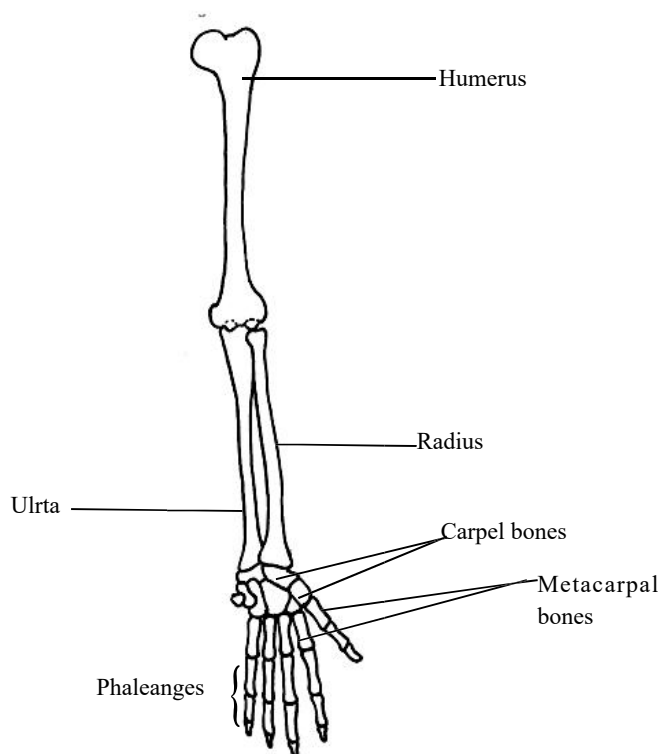

Figure 5.43: Bones of the upper limb

The adaptation of the human upper limb for movement through a wide range

Structure of upper limb is adapted for grasping, weight lifting and movement over a wide range.

Head of the humerus (the bone of the upper arm) forms an incomplete ball and socket joint (shoulder joint) in glenoid cavity of the scapula permitting a vast range of movements. The joint allows for flexion, extension, adduction, abduction, rotation and circumduction.

The distal end of the humerus has two articular surfaces. Through these surfaces, radius and ulna articulate with the humerus at the elbow joint. They articulate with the carpal bones at the wrist joint. Further ulna and radius are articulated with each other at the proximal and distal radio-ulna joints. In addition a fibrous joint connects the bones along their shafts which stabilize their association and maintain their relative position in spite of forces applied from the elbow or wrist. The elbow joint acts as a hinge joint which permits only flexion and extension of the fore arm.

The carpal bones which are arranged in two rows (proximal row and distal row) are closely fitted together so that there is limited amount of movement between them. Proximal row bones are associated with the wrist joint and distal row bones form joints with metacarpal bones. Wrist joint is present between the distal end of radius and three proximal carpal bones. This arrangement allows pronation (palm down) and supination (palm up) of the lower part of the upper limb. In addition the wrist can be flexed, extended, abducted and adducted.

The proximal ends of metacarpal bones in the palm articulate with carpal bones and their distal ends articulate with phalanges. The joints between metacarpal and phalanges allow movement of the fingers and permit the power grip. Fingers may be flexed extended, adducted, abducted and circumducted with the first finger more flexible than the other. The joint present at the base of the thumb between a specific carpal bone and the first metacarpal bone allows more mobility to the thumb than the other fingers. This leads to opposable nature of the thumb which permits the thumb to move perpendicular to the other fingers. This articulation permits precision grip which is unique to man.

Lower limb

Lower limb consists of femur (thigh bone), tibia (shin bone), fibula, patella (knee cap), seven tarsal bones (ankle bones), five metatarsal bones (bones of the foot) and fourteen phalanges (toe bones).

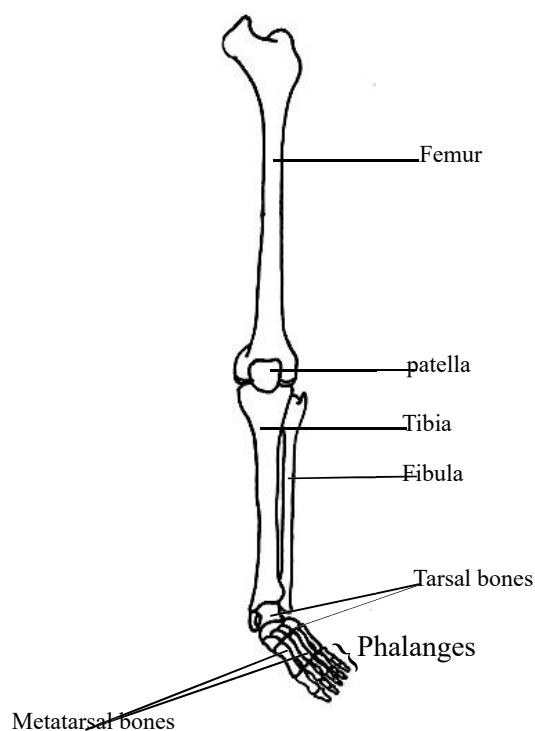

Figure 5.44: Adaptations of the lower limb for the erect posture, bearing of body weight and walking

Structure of the lower limb is adapted for strength, erect body posture, bearing body weight and walking.

Femur is the longest, heaviest and the strongest bone of the body. Head of the femur forms the hip joint (ball and socket joint) with the acetabulum of the hip bone of the pelvis. This hip joint is very sturdy and powerful as it bears all body weight when standing. The lower limb can be extended, flexed, abducted, adducted, rotated and circumducted at the hip joint.

Lower end of femur articulates with tibia and patella to form the knee joint. Tibia is the medial of the two bones. Possible movements at the knee joint are flexion, extension and a rotatory movement that locks the joint when it is fully extended. When this joint is locked it is possible to stand upright for a long period of time.

Femur transmits the weight of the body through the bones below the knee to the foot. All the lower ends of both tibia and fibula articulate with a specific tarsal bone to form the ankle joint. The ankle joint allows rising in tip toe and lifting toes towards the calf.

The arrangement of bones in the foot supported by associated ligaments and muscles gives the sole of the foot an arched or a curved shape. There are two longitudinal arches and one transverse arch in the foot. Curve running heel to toe is called the longitudinal arch and the curve running across the foot is called the transverse arch. In the upright position, these arches of the foot are important in distributing the weight of the body evenly whether stationary or moving.

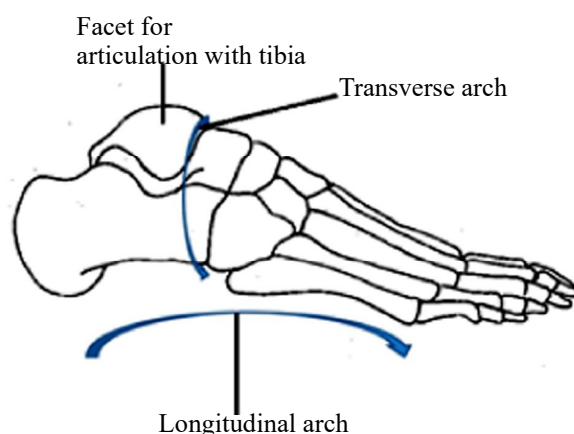

Figure 5.45 :The arches of foot

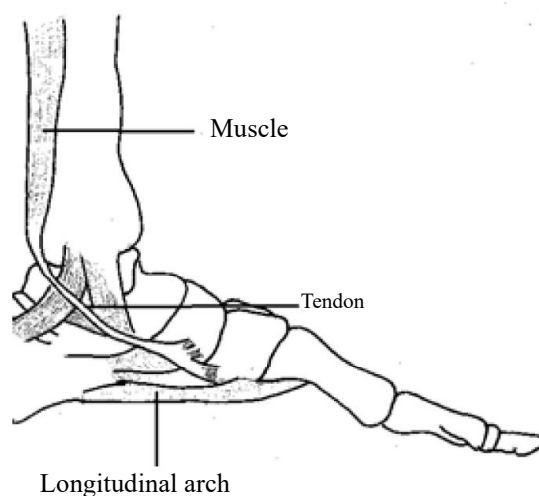

Figure 5.46 :The tendons and ligaments in the foot

Some disorders and abnormalities associated with human skeletal system

Osteoporosis

Osteoporosis is a condition associated with the reduction of bone density due to the exceedance of the bone reabsorption rate over the deposition rate. This gives in fragility to the bone tissue. This condition leads to immobility in joints and may cause fractures, skeletal deformities and bone pain. Factors causing osteoporosis include hormonal imbalances (especially at menopause), calcium deficiency and environmental factors.

Osteoarthritis

Osteoarthritis is a degenerative non-inflammatory disease that causes pain and restricted movements in the affected joints. Articular cartilage at the joints gradually become thinner so that articular surfaces of the bones come in contact and eventually the bones begin to degenerate; the outcome is pain. The cause of osteoarthritis is unknown. But risk factors include excessive use of affected joints, female gender, increasing age, heredity and obesity.

Slipped disc

The bodies of adjacent vertebrae are separated by intervertebral discs which serve as shock absorbers. These intervertebral discs consist of an outer ring of cartilage and a central core of soft gelatinous material. An injury or weakness can cause the inner portion of the intervertebral disc to protrude through the outer ring. This condition is called 'slipped disc'. This leads to pain and discomfort. If the slipped disc compresses a spinal nerve, there can be numbness and pain along the affected nerve. Slipped disc condition can arise when lifting heavy weights without bending knees.

Main types of joints in the human skeletal system

Main types of the joints in the human skeletal system are ball and socket joint, hinge joint and pivot joint.

- **Ball and socket joints**

In these joints, ball shaped head is connected with the cup shaped socket and allows for wide range movements such as flexion, extension, adduction, abduction, rotation and circumduction. There are two ball and socket joints available in the human body: Shoulder joint and hip joint. (Refer upper limb and lower limb)

- **Hinge Joints**

The articulating ends of the bone fit together in such a way so it looks like a hinge of a door. This allows only restricted movements such as flexion and extensions. Examples for hinge joints are elbow joint, knee joint, ankle joint and joints between the phalanges of the fingers and toes. (Refer upper limb and lower limb)

- **Pivot joints**

One bone fits into a hoop shaped ligament that holds it close to another bone and allows it to rotate in the ring formed by the ligament. These joints allow a bone or limb to rotate. For example head rotates by the pivot joint formed by the axis vertebrae within the transverse ligament ring and odontoid process of the atlas. (Refer vertebral column)

Skeletal muscle and mechanism of contraction

Features of skeletal muscle tissue

The skeletal muscles are generally attached to the skeletal system and mainly cause voluntary body movements. Skeletal muscle tissue is composed of bundles of long cylindrical cells. These cells are aligned parallel to each other along the length of the muscle. Each cell contain multiple nuclei close to the cell membrane. Inside the cell, bundles of myofibrils containing contractile microfilaments are located longitudinally along the length of the cell. Myofibrils in the muscle cell form repeating sections called sarcomeres. The repeating arrangement of sarcomeres within the skeletal muscle cell gives its striated appearance under the microscope. Sarcomeres are the basic contractile units of the striated muscle cell. Like smooth muscle cells and cardiac muscle cells, skeletal muscle cells show excitability or irritability (ability to receive and respond to stimuli), contractility (ability to contract or shorten), extensibility (ability to stretch or contract) and elasticity (ability to return to its original length after being stretched or contracted). The skeletal muscle is under the voluntary control of the somatic nervous system.

Structure of the sarcomere, basic mechanism of skeletal muscle movement

Sarcomeres are the repeating contractile units present within a striated muscle cell. The sarcomere is composed of myofibrils containing contractile thick filaments and thin filaments which are made up of specific proteins. The thin filaments (formed mainly from actin protein) attached at the Z line, a dense stripe which forms the borders of the sarcomere. The thick filaments (formed from myosin protein) are fixed (at the M line) in the middle region of the sarcomere. Sarcomeres are found repeatedly between two Z lines in a skeletal muscle cell. At the resting stage of myofibrils, thick and thin filaments are partially overlapped. At the edge of the sarcomere there are only thin filaments while at the center of the sarcomere only thick filaments are present. Such arrangement of thick and thin filaments in the sarcomeres permits the shortening of the skeletal muscle cell during contraction and return to the original state during relaxation. The mechanical function arising from sarcomeres is produced by actin (found in thin filaments) and myosin (found in thick filaments) proteins.

The skeletal muscle contraction is mainly voluntary and under the control of the somatic nervous system. Upon stimulation, individual muscle cells in the skeletal muscle shortens due to the shortening of its sarcomeres, and thus the whole muscle may contract. Converting muscle contraction to movement needs a skeleton to which the muscles attach. Skeletal muscle contractions pull on the tendons attached to the bones. If contraction of the muscle causes the muscle to shorten, the bone and the body part will move. When the nervous stimulation is stopped, the muscles will return to the original length after being contracted.

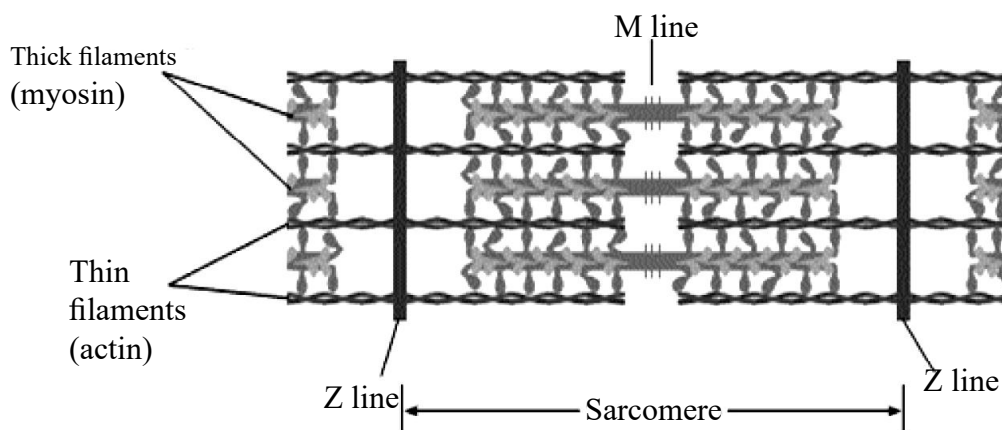

Figure 5.46: The arrangement of a sarcomere

Sliding filament theory is the currently accepted model of striated muscle contraction. According to this theory, when a skeletal (or cardiac) muscle cell contracts, the thick (myosin) filaments and thin (actin) filaments in each sarcomere slide past each other pulling the Z lines at each end of the sarcomere closer to one another shortening the sarcomeres and thus the muscle cell, while the two

groups of filaments in the sarcomere remain at a relatively constant length. Myosin is the motor protein that does muscle contraction by pulling on thin filaments (actin) in muscle cells. Each myosin molecule is composed of 'tail' region and 'head' region. In the thick filaments, these 'tail' regions are bundled together while the 'heads' are sticking out. The thin filaments are composed of actin molecules which have binding sites for the 'head' region of the myosin molecules. The head region of the myosin can also bind with an ATP molecule when its 'low energy state'.

When the ATP molecule is hydrolyzed to form ADP and phosphate while releasing energy, the myosin head enters into the 'higher energy state'. At this state, the myosin head binds to myosin binding site of actin forming a cross bridge. Thereafter the myosin head returns to its lower energy state by releasing ADP and phosphate, which pulls (slides) the thin filament toward the centre of the sarcomere and so shortening the sarcomere. When a new molecule of ATP binds to the myosin head, the cross bridge is broken, myosin head detaches from actin. A new cross bridge cycle begins again. The contraction of muscles requires many number of repeated cycles of binding and releasing. In each cycle, the myosin head is released from the cross bridge and newly bound ATP is hydrolyzed which promotes binding of myosin again to a new actin molecule. This process occurs along the entire length of every myofibril in the muscle cell. Since in the earlier cycle the thin filament has moved towards the centre of the sarcomere, a new binding site for the myosin head region is exposed in the thin filament. The entire process causes the thick and thin filaments in the muscle cell to slide past each other pulling the Z lines at each end of the sarcomere closer to one another shortening the sarcomere.

Many myosin heads can be found in one thick filament. Within one second, each of these heads can form cross bridges. Ca^{2+} and some other proteins also play a major role in muscle contraction. Myosin can only bind to actin when the binding sites on actin are exposed by the action of calcium ions.

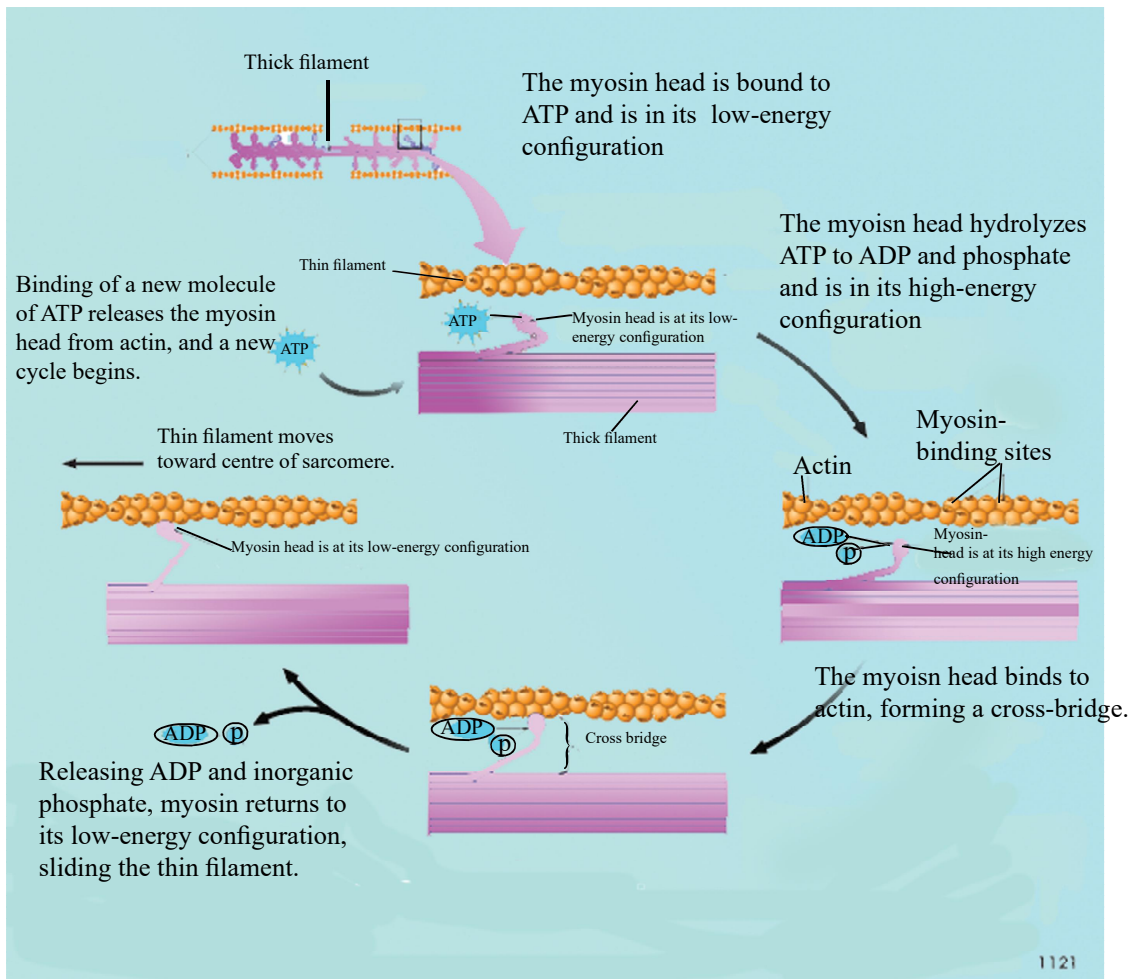

Figure 5.47: Interaction of actin and myosin in skeletal muscle cell contraction

06

Genetics

Scientific basis of Mendel's experiments

Mendelian Heredity (Mendelism)

Principles in heredity were first formulated by an Austrian Augustinian monk named Gregor Mendel, who is now considered the father of modern genetics. Mendel discovered the basic principles of heredity by breeding garden peas in carefully planned experiments.

His experiments were conducted decades before the concept of chromosomes. The later discovery of chromosomes as the carriers of genetic units supported Mendel's two basic laws of genetics which are now known as **Mendelism**.

Vocabulary in genetics

There are numerous heritable variations among individuals of a population such as brown, green, or blue eyes or black, brown, or blond hair in human population. A heritable feature that varies among individuals of a population, such as hair colour or eye colour is called a **character** in genetics. These heritable variants of a character in an organism, such as brown or blond hair or blue, brown or black eye colour in human are called as **traits**. These traits are transmitted from parents to offspring. Observable traits of an organism is known as phenotype.

Mendel has described about 'heritable factors' in explaining his experimental results. These heritable factors are identified to be **genes** in modern genetics. **Gene** is the basic unit by which genetic information is passed from parent to offspring. It is a DNA sequence residing usually at a specific **locus** on a particular chromosome and contributes to the development of one or more traits by coding for specific proteins or peptides. Locus (Loci in plural) is a fixed position on a chromosome.

There are alternative versions of genes which are called **alleles**. Alleles reside on the same locus of different chromosomes. Alleles vary in their sequence of nucleotides. This change can affect the function of the protein encoded by the gene and thus the phenotype of the organism. Each diploid organism has at least two copies of each gene, residing on the chromosomes received by the two parents. These copies could be identical or could differ from one another. The condition of

having two identical alleles for a given gene is known as **homozygous** state. Alternatively, having two different alleles for a given gene is referred to as **heterozygous** state.

Phenotype is brought about by the interaction between genotype of the individual with its environment. The genetic make up, or set of alleles, of an organism is known as its **genotype**. An individual's genotype could be either homozygous or heterozygous with respect to a given gene.

At heterozygous state, the allele which determines the organism's phenotype by masking the expression of the other is referred to as the **dominant allele**. The trait produced by the dominant allele is known as the **dominant trait**. The allele which does not exhibit any noticeable effect on the organism's phenotype at heterozygous state is referred as the recessive allele. The trait hidden on the recessive allele is the **recessive trait**. However, they express their trait when they exist in homozygous state.

Mendel tracked only those characters that occurred in two distinct, contrasting phenotypic forms, such as tall stem length vs. short stem length or purple flower colour vs white flower colour. Such traits are referred to as **contrasting traits**.

Mendel used only the **pure breeding** (sometimes called **true breeding**) varieties for his experiments. Pure breeding plants are obtained by self-pollinating over many generations, producing only the same variety as the parent plant. These uniform lines produced from self-fertilization of pure breeding varieties over many generations are called **pure lines**.

During his experiments, Mendel cross-pollinated pure-breeding garden pea plant varieties which shows contrasting **traits**. For example, purple-flowered plants were cross bred with white-flowered plants. Mating or crossing of two pure-breeding varieties with contrasting **traits** is called **hybridization**. Parental generation is referred to as the **P generation** (parental generation). Plant progeny resulted from these hybridization events are referred to as **F₁ generation** (First Filial generation, the word filial from the Latin word for "son"). The progeny that results from the self or cross pollination between these F₁ generation plants are known as **F₂ generation** (Second Filial generation).

An organism that is heterozygous with respect to a single gene of interest resulting from a cross between parents having homozygous condition for different alleles of specific gene is referred to as a '**monohybrid**'. Breeding experiment conducted between two organisms with heterozygous condition for a specific character is referred to as '**monohybrid cross**'.

An organism that is heterozygous with respect to two genes of interest resulting from a cross between

parents having homozygous conditions for different alleles of two specific genes is referred to as a '**dihybrid**'. Breeding experiment conducted between two organisms with heterozygous conditions for two specific characters is referred to as a '**dihybrid cross**'.

Breeding an organism having unknown genotype for a specific dominant trait with an organism having homozygous recessive condition for the same specific trait is called a **test cross**. This is usually done to reveal the unknown genotypes for specific dominant traits in an organism.

Monohybrid Cross

Mendel derived his first law of inheritance by following only a single character in one breeding experiment, such as flower colour. He started by crossing pure breeding parents with contrasting **traits**. All the F_1 progeny produced from pure breeding parents are **monohybrids**, meaning that they are heterozygous for the particular character being followed in the cross.

F_1 hybrid pea plants were then self- or cross-pollinated and F_2 generation was produced to explore the traits resulting from a monohybrid cross (Figure 6.1).

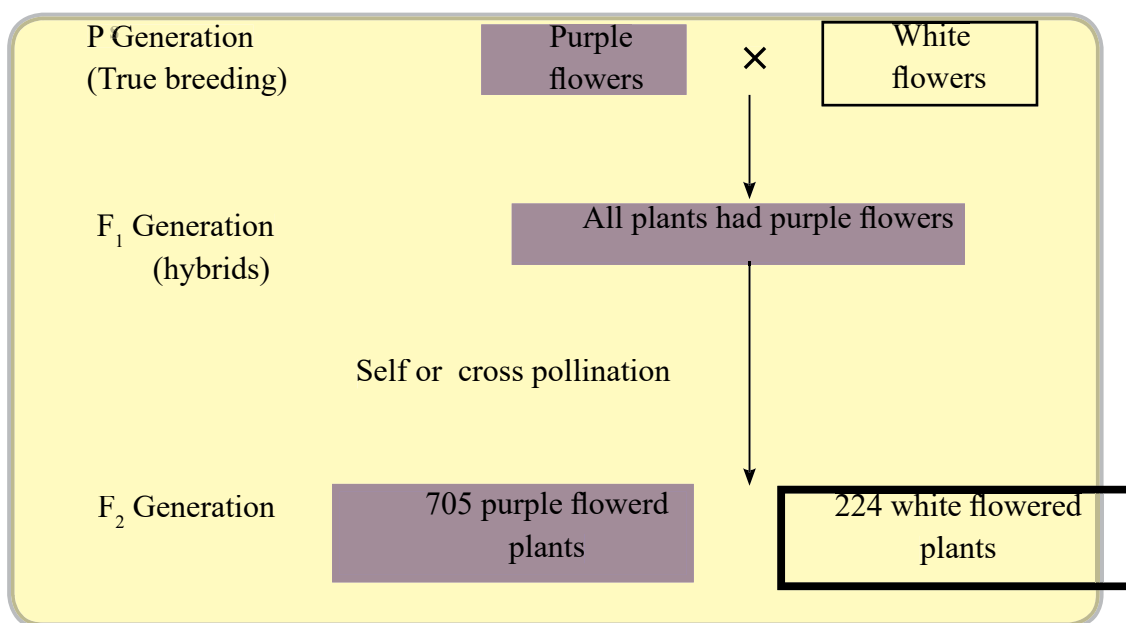

Figure 6.1: Mendel's experiment to investigate the inheritance patterns of a single character over two generations

Mendel, during his experiment, crossed pure breeding purple flowered plants and white flowered plants. Then he allowed the resulting F_1 hybrids to self and cross-pollinate with other F_1 hybrids. Finally, he observed the F_2 generation plants for the colour of the flowers.

During his observation, all F_1 plants produced purple colour flowers. However, in the F_2 generation, both purple and white flowered plants appeared in a ratio of approximately 3: 1.

Among the heterozygote resulted in the F_1 generation, the “heritable factor” responsible for producing white flowers were suppressed in presence of the "heritable factor" that produces purple flowers. As a result, the heterozygotes were all producing purple colour flowers. Therefore, the ‘heritable factor’ for purple flower colour is dominant to the white (dominant trait). Accordingly, the factor for white flower colour is referred as the recessive trait.

Mendel observed that the same pattern of inheritance consistently occurred in six other characters; position of the flower, colour of the seed, shape of the seed, shape of the pod, colour of the pod and the length of the stem.

Mendel’s first law of inheritance: The law of segregation

Mendel’s first law was put forward to explain the 3:1 inheritance pattern observed among the F_2 offspring in his monohybrid experiments using Pea plants.

As per his hypothesis, each ‘heritable character’ is determined by two "heritable factors" which are known as alleles. During the formation of gametes, the alleles for a ‘heritable character’ are separated and get in to each of the gametes formed. This is now known as **Mendel’s law of segregation or Mendel’s first law in inheritance.**

Analyzing genotype and phenotype ratios using Punnett square

In Pea plants, Mendel observed two different **traits** based on stem lengths; tall and dwarf. For his experiments, pure breeding tall and dwarf Pea plants were selected for cross pollination. Thereafter the F_1 generation was self pollinated in order to obtain F_2 generation.

During self pollination of F_1 hybrids, gametes carrying different alleles fuse randomly. Such random fusion of gametes produces zygotes with four genetic combinations. A Punnett square can be used to illustrate these genetic combinations. A Punnett square is a graphical representation of the possible genotypes of an offspring arising from a particular cross or breeding event. An example is given figure 6.2.

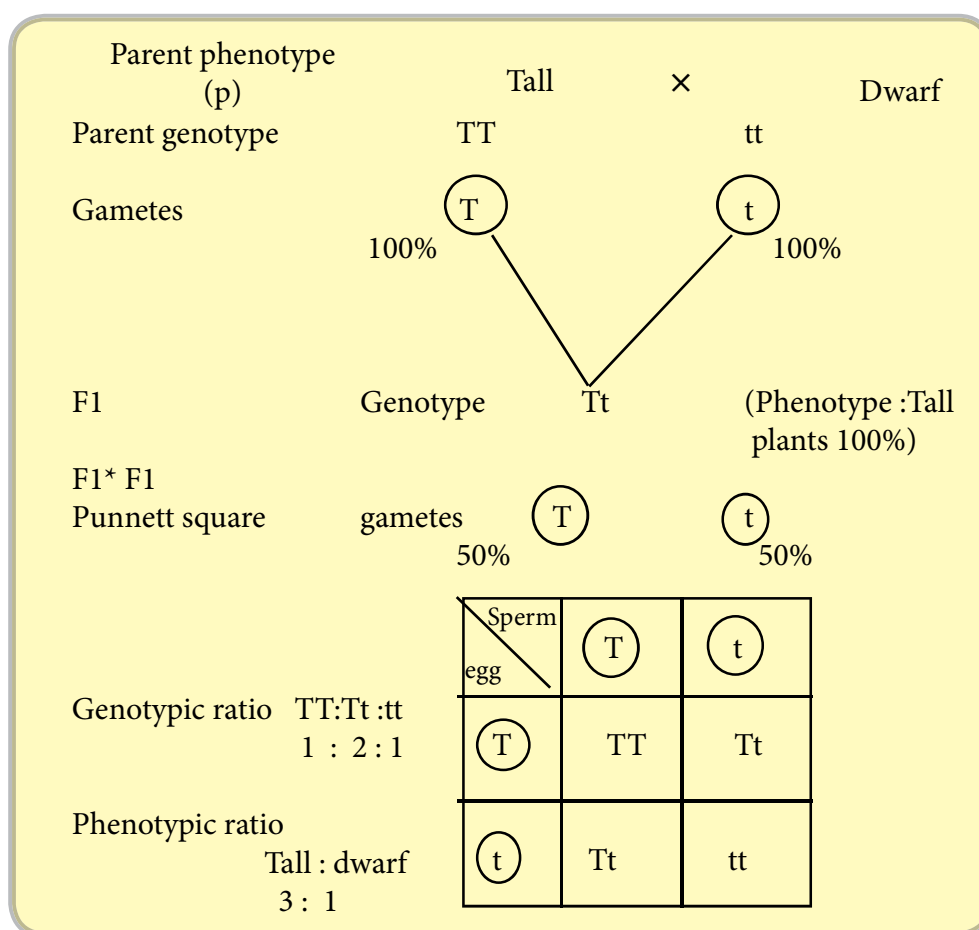

Figure 6.2: Mendel's law of segregation shown with the aid of the punnett square

Dihybrid Cross

Mendel identified his second law of inheritance by following two characters at the same time, using **dihybrid crosses**. A cross between two homozygous (true breeding) organisms with contrasting traits for two specific characters being followed is known as a **dihybrid cross**. The aim of the Mendel's dihybrid cross experiment was to find out whether the alleles for one character assort into gametes dependently or independently of the alleles of the other character.

Mendel crossed a true-breeding plant with yellow-round seeds with a true breeding plant with green-wrinkled seeds (Figure 6.3). The cross produced dihybrid F_1 plants, all of which have yellow-round seeds. As shown by the monohybrid crosses, the allele for yellow seeds is dominant (Y) over the allele for green seeds (y) which is recessive. likewise, the allele for round seed is dominant (R), and the allele for wrinkled seed is recessive (r). The F_1 hybrids, are heterozygous for the two characters being followed in the cross (YyRr). The cross between F_1 dihybrids produced the F_2 generation.

This lead towards two alternative hypothesis for inheritance which predict different phenotypic ratios as shown in **Figure 6.3**.

1. The two characters could be transmitted from parents to offspring as a package. The dominant Y and R alleles or the recessive y and r alleles are passed together, generation after generation. This is called **dependent assortment** of alleles.

According to this hypothesis only two types of gametes are possible; i.e. YR and yr. Thus the phenotypic ratio of the F₂ generation would be similar to that of a monohybrid cross (3:1)

2. The two characters (seed colour and seed shape) could be transmitted from parents to offspring independent of each other i.e. Y allele could be passed either with R or r allele vice versa. This is called **independent assortment** of alleles.

This hypothesis predicts four different allelic combinations for a bi-allelic locus and thus four different types of gametes from F₁ generation; i.e. YR, Yr, yR and yr. According to this, both male and female gametes have four possibilities for each. Therefore, during the union of male and female gametes, there are 16 (4 × 4) equally probable ways in which the alleles can combine to produce the F₂ generation. As shown in Figure 3, these combinations would give rise to four different phenotypes with a ratio of 9:3:3:1 (nine Yellow round to three Green-round to three Yellow-wrinkled to one Green-wrinkled).

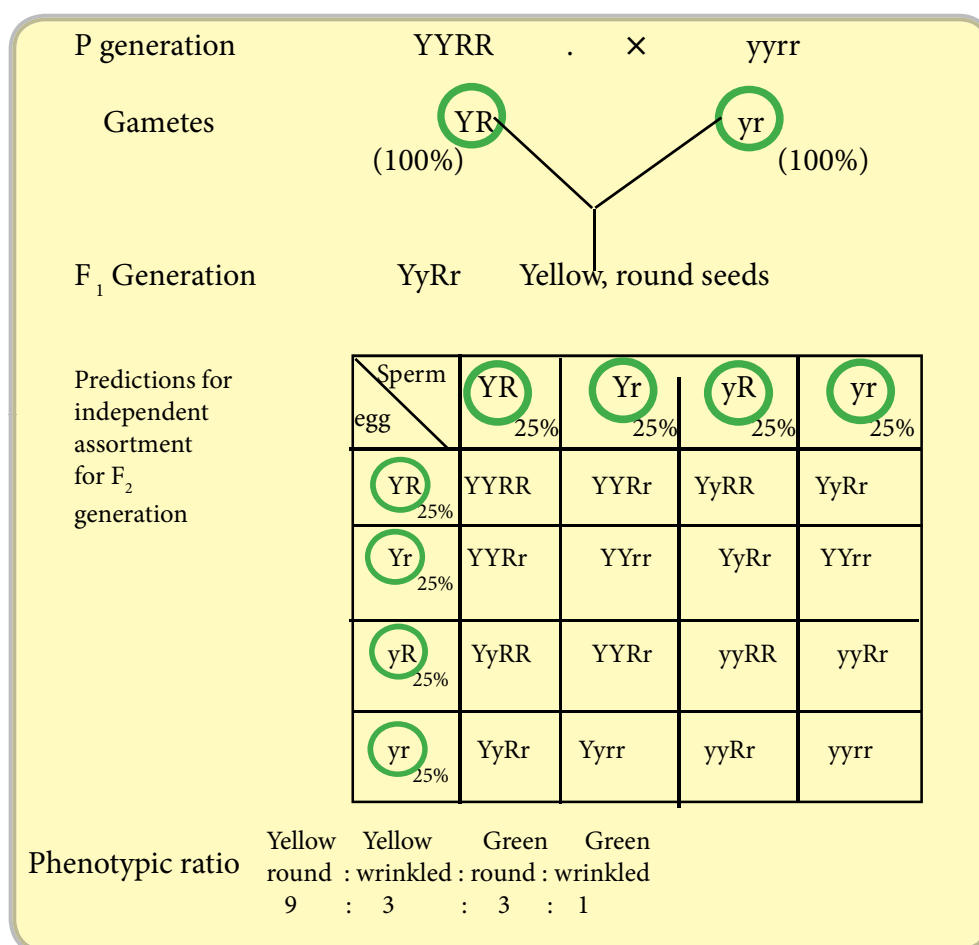

Figure 6.3: Alternative forms of inheritance patterns possible in a dihybrid cross

Mendel's experiment produced the four distinct phenotypes (Yellow-round, Green-round, Yellow-wrinkled and Green-wrinkled seeds) predicted in the second alternative hypothesis in the ratio of 9:3:3:1. This showed that, the alleles responsible for each trait assorted independently of those of the other.

Mendel's second law of inheritance (The law of independent assortment)

Based on these experiments, Mendel put forward his **second law of inheritance - the law of independent assortment**. The law states that, alleles separate and pair up independently during the formation of gametes. As a result of that, two or more genes assort independently irrespective of the other.

However, according to current knowledge, this condition applies to two circumstances only;

- To genes located on different chromosomes (genes on non-homologous chromosomes)
- To genes located far apart on the same chromosome

Success of Mendel's experiments

Mendel followed a scientific approach in conducting his experiments. The following features in his experiments helped him to unravel the two fundamental principles of heredity.

- Mendel carried out thousands of genetic crosses of any given kind. This allowed his results to closely resemble the probability predictions. Usually, the larger the sample size, the closer the results to the value predicted based on the probability.
- He kept accurate records of his results. These records helped him to trace the patterns which otherwise would go unnoticed.
- He usually followed up each cross for at least two offspring generations (F_1 and F_2). This helped him to uncover some of the traits hidden in the F_1 generation.
- He did a quantitative analysis of the phenotypes of the resulting offspring.

Desirable properties in garden peas for genetic experiments

Garden peas (*Pisum sativum*) carry following desirable properties which makes it a suitable organism to study patterns of inheritance.

- Pea plants are available in many varieties with contrasting traits.
- The generation time is short.
- A large number of offspring is produced from each cross.
- Crossing between the plants could be strictly controlled (self/ cross pollination).

Probability laws and Mendelian inheritance

Mendel's laws of segregation and independent assortment reflect the same rules of probability that applies to tossing coins, rolling dice, and drawing cards from a deck. **Probability** measures

how likely an event is to occur out of the number of possible outcomes. It is calculated by dividing the number of events of interest by the number of total possible outcomes.

1. The probability scale ranges from 0 to 1.

An event that is certain to occur has a probability of 1, while an event that is certain not to occur has a probability of 0.

During allele segregation in a F_1 plant (heterozygous) of a monohybrid cross,

-probability of each egg carrying the dominant allele = $1/2$

-probability of each egg carrying the recessive allele = $1/2$

2. The probabilities of all possible outcomes for an event add up to 1.

During allele segregation in a heterozygous F_1 plant, probability of all events (having dominant and recessive alleles) = $1/2 + 1/2 = 1$

3. When the occurrence of an event does not affect the occurrence of another event (independent events), the probability of simultaneous occurrence of both events can be obtained by multiplying the probability of one event by the probability of the other event. This is known as the **Multiplication Rule** or **Product rule in Probability**.

In Mendel's monohybrid crosses, for a F_2 plant to have wrinkled seeds (rr), both the egg and the sperm that come together must carry the r allele.

The probability that the egg will have an r = $1/2$

The probability that the sperm will have an r = $1/2$

The probability of both gametes at fertilization carrying r allele = $1/2 \times 1/2 = 1/4$

4. The probability that any one of two or more mutually exclusive events will occur is calculated by adding their individual probabilities. This is the addition rule or sum rule of probability.

There are two possible mutually exclusive ways for producing F_2 heterozygotes.

i. The dominant allele come from the egg and the recessive allele from the sperm; the probability of the event = $1/4$ (according to example in above 3rd sentence)

ii. The recessive allele from the egg and the dominant allele from the sperm; the probability of the event = $1/4$ (according to example in above 3rd sentence)

So, the probability of getting an F_2 heterozygote = $1/4 + 1/4 = 1/2$

Prediction of the inheritance patterns in multifactorial crosses

When the pattern of inheritance of two or more characters of an organism is being traced during a genetic cross, it could be called as multifactorial cross. Finding out the outcomes of a multifactorial cross through a Punnett square may be a difficult task. Therefore, applying rules of probability may be useful to predict the outcomes of a multifactorial crossing.

According to the law of segregation, a multifactorial cross can be considered equivalent to multiple independent monohybrid crosses occurring simultaneously.

E.g. 1: Dihybrid cross for seed color and seed shape,

Probabilities for seed color (based on the Punnett square for monohybrid cross)

Seed color	
Genotype	Probability
BB	$\frac{1}{4}$
Bb	$\frac{1}{2}$
bb	$\frac{1}{4}$

Seed shape	
Genotype	Probability
RR	$\frac{1}{4}$
Rr	$\frac{1}{2}$
rr	$\frac{1}{4}$

B: dominant allele for black colour seed b: recessive allele for brown coloured seeds

R: dominant allele for round shaped seeds r: recessive allele for wrinkled shaped seeds.

The probability of each of the genotypes in the F_2 generation can be determined by using the multiplication rule.

Probability of BbRr = $\frac{1}{2}$ (probability of Bb) \times $\frac{1}{2}$ (probability of Rr) = $\frac{1}{4}$

Probability of bbRr = $\frac{1}{4}$ (bb) \times $\frac{1}{2}$ (Rr) = $\frac{1}{8}$

Probability of brrr = $\frac{1}{4}$ (bb) \times $\frac{1}{4}$ (rr) = $\frac{1}{16}$

E.g. 2: A trihybrid cross for flower color, seed color and seed shape.

Y: Dominant allele for yellow colour petals y: Recessive allele for white coloured petals

B: Dominant allele for black coloured seeds b: Recessive allele for brown coloured seeds

R: Dominant allele for round seeds r: Recessive allele for wrinkled alleles

YyBbRr x yyBbrr

(YyBbRr): Yellow coloured petals with black round seeds

(yyBbrr): white coloured petals with black round seeds seeds

Flower color	
Genotype	Probability
YY	0
Yy	$\frac{1}{2}$
yy	$\frac{1}{2}$

Seed shape	
Genotype	Probability
BB	$\frac{1}{4}$
Bb	$\frac{1}{2}$
bb	$\frac{1}{4}$

Shape of the seeds	
Genotype	Probability
RR	0
Rr	$\frac{1}{2}$
rr	$\frac{1}{2}$

Assume that unknown pea plant is having genotype of TT

The above crossing has resulted 640 plants in the F1 generation. Determine the number of plants exhibits dominant phenotype for at least two characters.

- Possible genotypes with their individual probabilities for above conditions

$$YyBBRr: \frac{1}{2} (\text{probability of } Yy) \times \frac{1}{4} (BB) \times \frac{1}{2} (Rr) = 1/16$$

$$YyBbRr: \frac{1}{2} \times \frac{1}{2} \times \frac{1}{2} = 1/8$$

$$YyBBrr \quad \frac{1}{2} \times \frac{1}{4} \times \frac{1}{2} = 1/16$$

$$YyBbrr \quad \frac{1}{2} \times \frac{1}{2} \times \frac{1}{2} = 1/8$$

$$YybbRr \quad \frac{1}{2} \times \frac{1}{4} \times \frac{1}{2} = 1/16$$

$$yyBbRr \quad \frac{1}{2} \times \frac{1}{2} \times \frac{1}{2} = 1/8$$

$$yyBBRr \quad \frac{1}{2} \times \frac{1}{4} \times \frac{1}{2} = 1/16$$

- Probability of exhibiting at least two dominant characters = $1/16 + 1/8 + 1/16 + 1/8 + 1/16 + 1/8 + 1/16 = 10/16 = 5/8$

- Number of plants expected to exhibit at least two dominant characters = $5/8 \times 640 = 400$ plants

The testcross

This is a deliberate breeding process performed in order to determine the unknown genotypes. The genotype of an individual showing dominant trait may be due either to double dominant genotype or to heterozygous status. This involves the crossing of an organism having unknown genotype for a selected phenotype along with another organism from same species having homozygous recessive condition for same character.

Testcross performed during the monohybrid cross is called as monohybrid testcross. On the other hand, test cross performed during the dihybrid cross is called as dihybrid testcross.

Monohybrid testcross

Let's consider an example for monohybrid testcross. In this example we want to know the genotype of the given tall pea plants. In order to do that, we will cross the tall pea plant with the dwarf pea plant. Since dwarf is a recessive trait the genotype of it will be tt.

There may be two possible genotypes for tall pea plants;

- TT
- Tt

Assume that unknown pea plant is having genotype of TT

Cross between TT and tt will result the following.

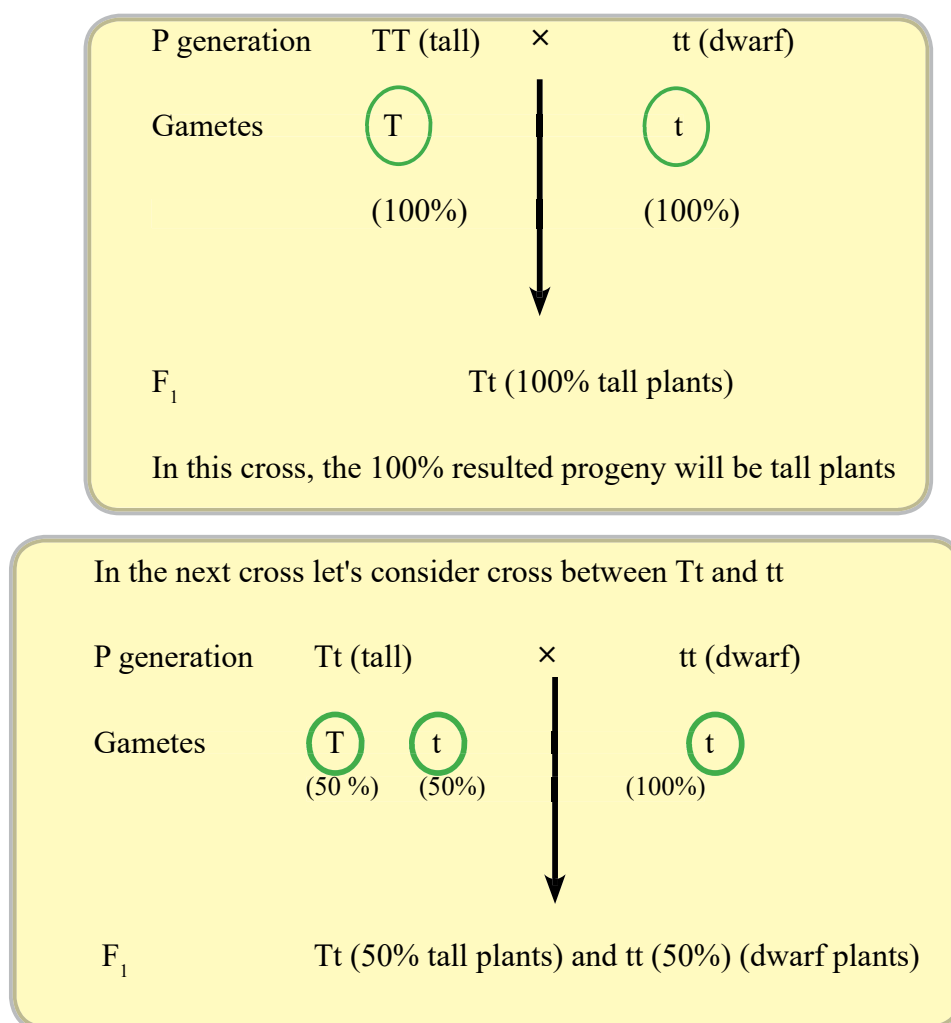

Figure 6.4: Two possible outcomes of a monohybrid test cross

Dihybrid testcross

When an individual with dominant traits for two characters (e.g. RrBb) is crossed with a pure recessive for both characters (wwbb), it is known as a **dihybrid testcross**.

For example, let's consider a cross between plants having red coloured flower petals with black coloured seeds and white coloured flower petals with brown coloured seeds.

The possible genotypes for red coloured petals with black coloured seeds are RrBb/ RRBb/RrBB/ RRBB and for white coloured petals with brown coloured seeds is wwbb.

If the unknown phenotype is RrBb;

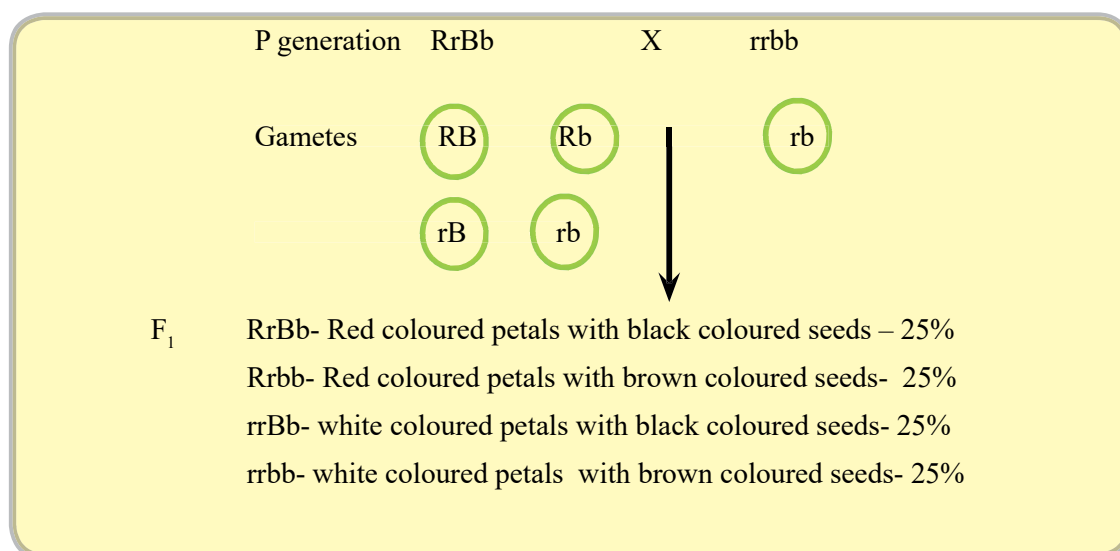

Figure 6.5: (a) Possible outcomes of a dihybrid test cross

In this example, above four phenotypes are possible with 1:1:1:1 ratio.

If the unknown phenotype has the RRBb genotype, the resulting dihybrid cross will produce following phenotypes;

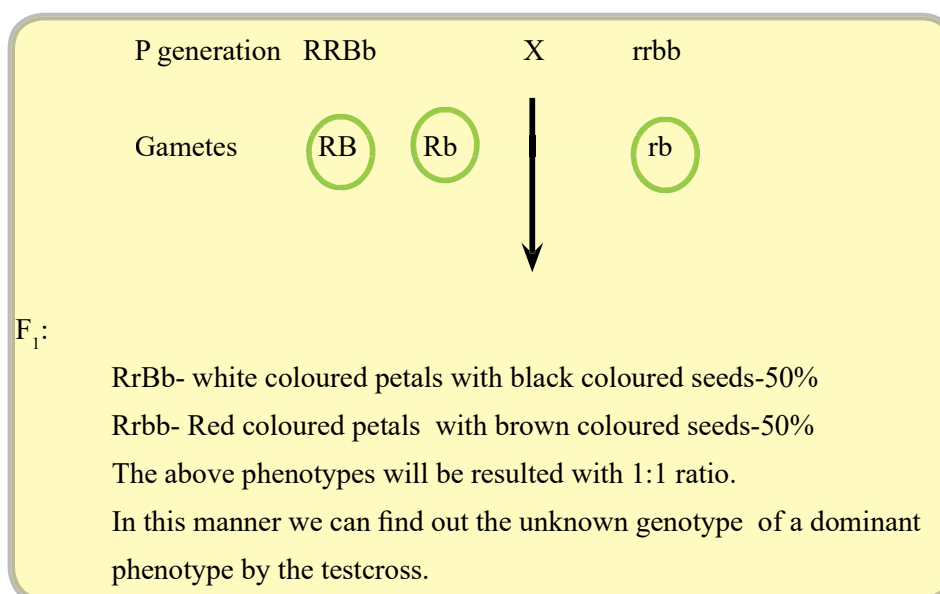

Figure 6.5: (b) Possible outcomes of a dihybrid test cross

Patterns of inheritance of Mendelian characteristics in humans

Common Mendelian characters

Many human traits follow Mendelian patterns of inheritance. Some common examples are stated below;

Attached or detached earlobe:

The extent to which the earlobe is attached to the head is inherited in the Mendelian pattern. The attached earlobe is a recessive trait. Presence of both copies of the recessive allele (homozygous recessive condition) for ear lobe attachment would result in attached ear lobe.

Widow's peak:

The pointed contour of the hairline on the forehead is known as Widow's peak. It is due to a dominant allele, W. Therefore, all individuals who lack a widow's peak must be homozygous recessive (ww).

Dimples on cheek:

Cheek dimples are a genetically transmitted trait found in the muscle of the cheek.

When a person smiles, the shorter muscle on the face pulls up the facial skin. This, in turn, creates a slight depression in the skin, which is called dimple. Dimples often occur on both the cheeks. A single dimple on one cheek is a rare phenomenon. Dimple is a dominant trait and inherited in Mendelian fashion.

Bent thumb (Hitchhiker's thumb) and Straight thumb

Hitchhiker's thumbs is a condition where thumb bend backwards while stretching due to the hyper extensibility of interphalangeal joints. Having the dominant 'S' allele would produce the dominant phenotype of straight thumb. The absence of the dominant alleles would allow the thumb to bend.

Rolling or non-rolling tongue

The ability to roll the lateral edges of the tongue upwards into a tube is known as tongue rolling. The tongue's intrinsic muscles allow some people to form their tongues into specific shapes. Rolling the tongue into a tube shape is a dominant trait with simple Mendelian inheritance.

Pedigree analysis

Diagrammatic representation of the inheritance of a particular trait within a given family tree, is called pedigree chart. It is constructed by collecting data for many generations within a given family, so that the pattern of inheritance can be understood.

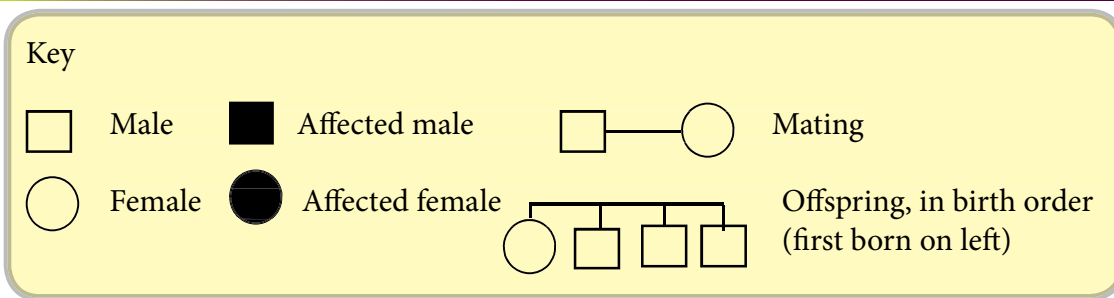

Figure 6.6: Standard Pedigree Symbols

Common Mendelian characteristics in humans analysed with pedigree charts

Widow's peak:

The inheritance of the trait, widow's peak, over three generations in a particular family is represented in the pedigree chart given below. As shown in figure 6.7, only one grand parent had widow's peak, out of the two pairs. Since widow's peak is a dominant character, grand parents without widow's peak should be homozygous recessive (ww) for the trait. In the next generation some individuals showed the widow's peak, while the others did not. The two grand parents, who express the widow's peak should be heterozygous (Ww) for the condition. Likewise, the two parents of the third generation, who are showing widow's peak should be heterozygous for it, as one of both their parents (1st generation) are homozygous recessive (ww). the third generation with widow's peak can carry either WW or Ww genotype, as both their parents are having the trait.

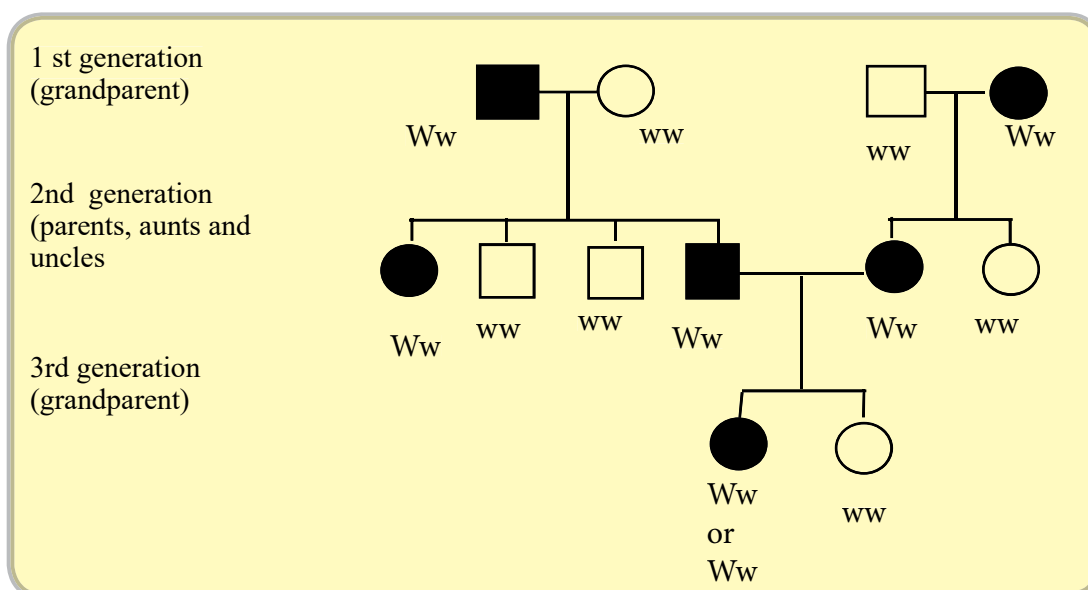

Figure 6.7: Inheritance of Widow's peak

Attached ear lobe

Attached ear lobe, as explained earlier, is a recessively inherited character. In the pedigree chart given below, the inheritance of the trait is analysed in the same family that was used to study the widow's peak. The dominant allele, which is causing the free ear lobe is denoted with 'F' while recessive allele is denoted with 'f'.

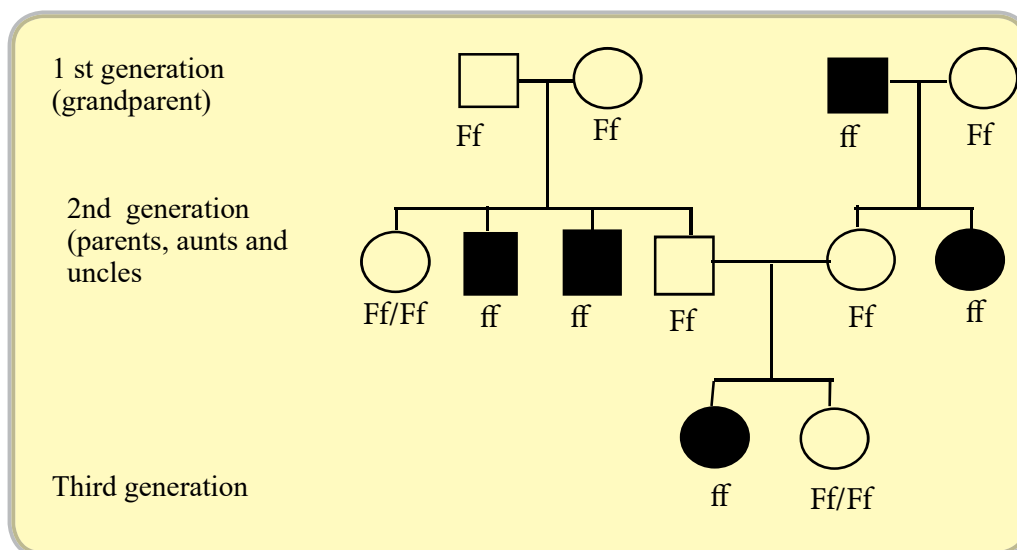

Figure 6.8: The pedigree chart showing the inheritance pattern of attached lobe

In the first generation, both parents lacking the attachment of ear lobes, resulted mixed progenies with attached and free ear lobes. This tells us that those two parents were heterozygous (Ff), and among the progeny, two males with attached ear lobes carry homozygous recessive alleles (ff) and a male and female with free ear lobe may carry heterozygous (Ff) or homozygous dominant alleles (FF or Ff). Another cross happened at the first generation between a male with attached ear lobe and a female with free ear lobe. This resulted one daughter with attached ear lobe. Therefore, she must possess ff and the other may be FF or Ff. A male from one family and a female from another family, at the second generation expressing free ear lobe phenotype, had resulted progeny having two females, one with attached ear lobes and the other with free ear lobes for the third generation. Therefore, the second generation male and female crossed with free ear lobes must be Ff. Third generation female with attached ear lobes must carry ff genotype and the other may carry either FF or Ff.

The probability that another child from the same family will have attached earlobes could be calculated using a monohybrid cross (Ff X Ff). Since homozygous recessive (ff) genotype is causing the condition, the probability is 1/4 for each child.

The chance that a child born to the family will have both the widow's peak and attached earlobes can be calculated using probability rules. Assuming that the alleles corresponding to the two

characters are on different chromosomes, the two pairs of alleles assort independently in this dihybrid cross (WwFf X WwFf).

Thus according to multiplication rule,

Chance of having both widow's peak (WWff/Wwff)

and attached ear lobe = Chance of widow's peak x chance of attached earlobe

$$= \frac{3}{4} \times \frac{1}{4}$$

$$= \frac{3}{16}$$

Non-Mendelian inheritance

Non-Mendelian inheritance refers to inheritance patterns in which traits do not segregate in accordance with **Mendel's** laws of inheritance. Phenotypes that do not appear in ratios predicted by Mendelian genetics are the indicators of Non-Mendelian inheritance.

Examples for non-mendelian patterns

- when alleles are not completely dominant or recessive (incomplete dominance and co-dominance),
- when a particular gene has more than two alleles (polyallelism)
- when a single gene produces multiple phenotypes (pleiotropy)
- sometimes two or more genes are involved in determining a particular phenotype (epistasis and polygenic inheritance)
- gene linkage
- genes which are located in sex chromosomes exhibit a different pattern of inheritance in males and females due to the unequal distribution of genes in their sex chromosomes.

Incomplete dominance

The phenomenon of dominant allele completely masking the recessive phenotype, resulting similar phenotypes for both homozygous dominant zygote as well as heterozygous zygote is called **complete dominance**.

On the other hand, at the heterozygous state, the phenomenon of expressing blend phenotypes from both alleles is called **incomplete dominance**. Degree of expression of each allele in the blend phenotypes may vary based on the nature of the alleles.

In *Mirabilis jalapa* (Four o'clock plant), there are several types of flower colours. When red flowered plants are crossed with white flowered plants, all the F₁ hybrids (heterozygotes) have pink flowers (Figure 6.8). This third, intermediate phenotype results from flowers of the heterozygotes having less red pigment than the red homozygotes.

When these F_1 pink flowers are self-pollinated or crossed among themselves to raise F_2 generation, they produce red (C^{RR}), pink (C^{RW}) and white (C^{WW}) flowers giving 1:2:1 ratio. This phenotypic ratio is identical with genotypic ratio because heterozygotes are phenotypically intermediate between two homozygous types.

Note: Since, neither allele is dominant, instead of upper- and lowercase letters, a superscript is used to indicate the trait; i.e. C^R for red colour and C^W for white colour.

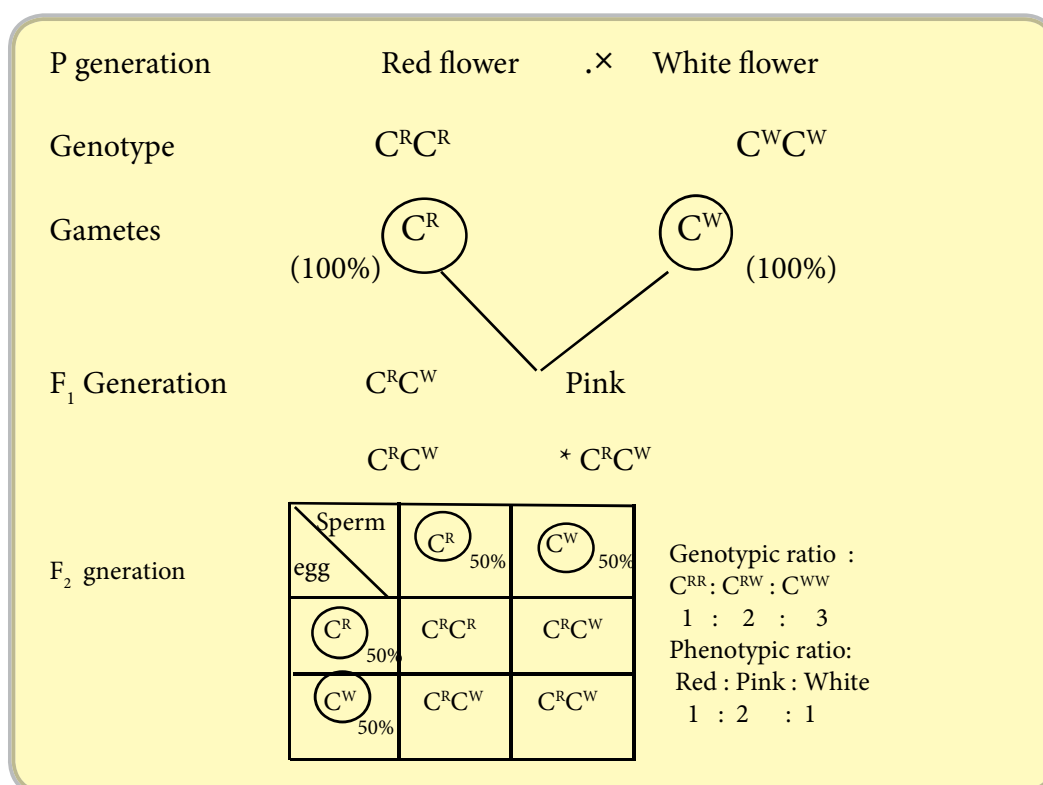

Figure 6.9: Incomplete dominance in *Mirabilis jalapa* flower colour gene

Codominance

In certain traits, at heterozygote state, expression of both alleles contributes equally to the phenotype. Such phenomenon is called **co-dominance**.

For example, a person with AB blood group type has both A and B carbohydrates on the surface of red blood cells at the same time. The two carbohydrates are added to the surface of RBC by enzymes encoded by the I^A and I^B alleles of a single gene. A heterozygous individual would express both carbohydrates ($I^A I^B$) in an equal manner.

Likewise,

Homozygotes for I^A allele ($I^A I^A$) will carry only A carbohydrate on RBC.

Homozygotes for I^B allele ($I^B I^B$) will carry only B carbohydrates on RBC.

As shown below, the F_1 progeny resulting from the mating of two homozygous individuals for each allele would consist of individuals only of AB blood group. F_2 generation produced by the possible mating with in F_1 progeny or heterozygous individuals for the AB alleles, would produce the three phenotypes, blood type A: AB: B at a ratio of 1:2:1.

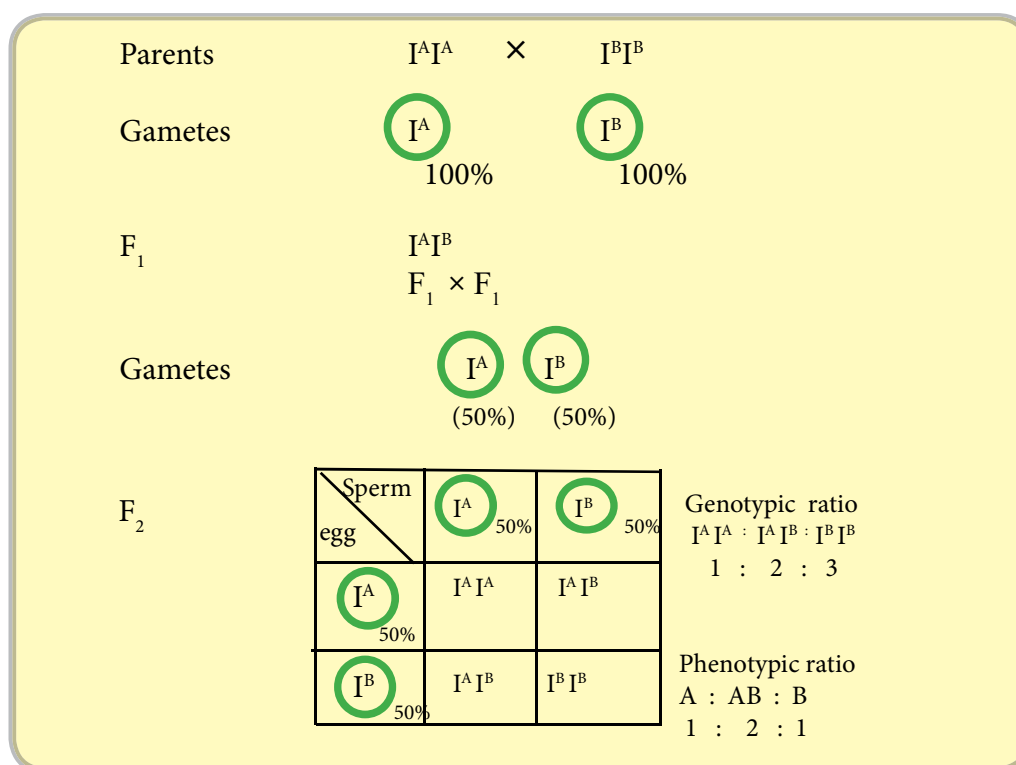

Figure 6.10: Codominance in ABO blood grouping

As shown, the F_2 phenotype ratios in both incomplete dominance and co-dominance are 1:2:1. Hence the two phenomena cannot be differentiated using F_2 phenotypic ratios.

The key to differentiate between incomplete dominance and co-dominance is that in incomplete dominance F_1 generation shows a different phenotype than both the parents whereas in co-dominance F_1 generation shows both the parental traits together.

Polyallelism (Multiple alleles)

Polyallelism refers to the presence of multiple alleles for a single genetic locus, a phenomenon where certain traits are determined by the combination of more than two types of alleles.

E.g. there are three alleles called I^A , I^B , and i for a single genetic locus which at different combinations determine ABO blood groups in humans.

In any diploid individual there are only two of the several alleles are present.

As mentioned earlier, the alleles I^A and I^B code for enzymes that add A and B carbohydrates to the surface of red blood cells. The two alleles are in a co-dominant relationship. However, the allele 'i' results in lack of these carbohydrates on the red cell surface and it is recessive to both I^A and I^B alleles. Therefore, both $I^A i$ and $I^B i$ genotypes will result in dominant phenotypes; i.e. having either the A or B carbohydrates. The ii genotype will result in the recessive trait of not having either of the carbohydrates.

Thus, based on the presence of the two carbohydrates, a person's blood group may be one of four types as follows: type A (carbohydrate A present), type B (carbohydrate B present), type AB (both carbohydrates A & B present), or type O (neither of the two carbohydrates present).

F_1 and F_2 generations resulting from a mating between individuals with different blood groups are shown below

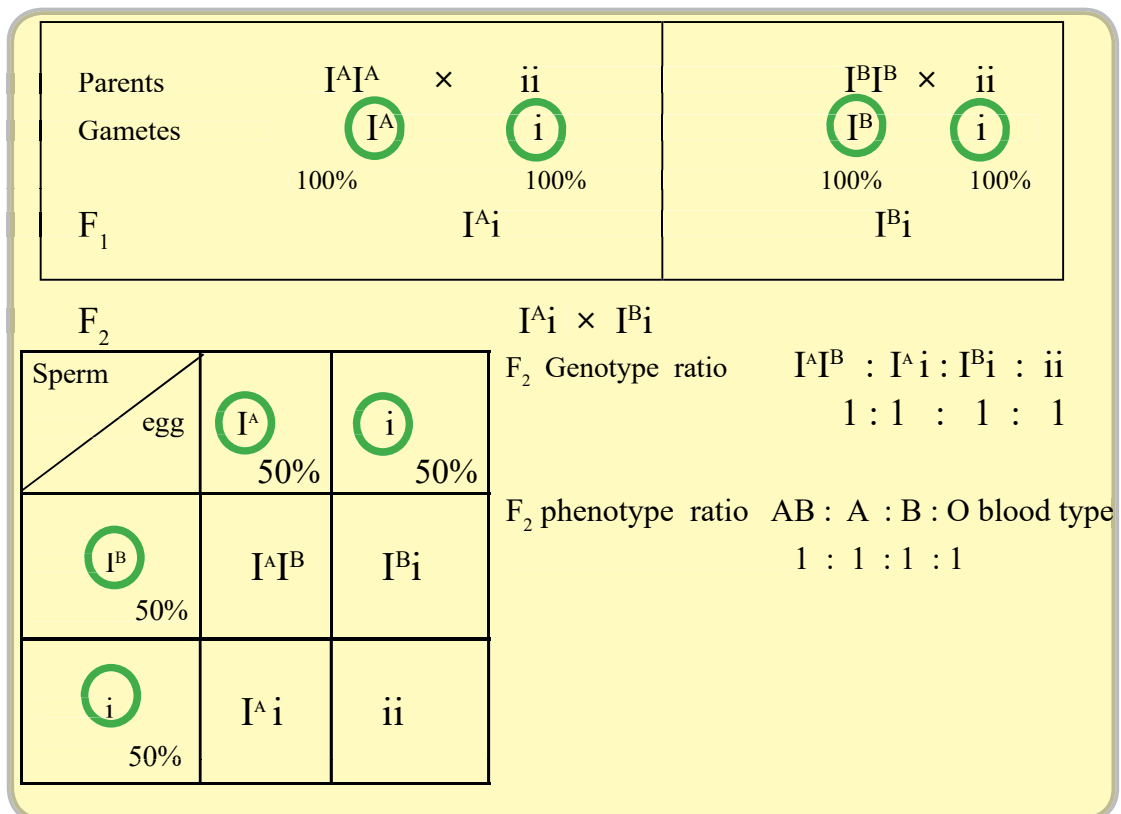

Figure 6.11: Multiple alleles for the ABO blood groups

Epistasis

Epistasis is the phenomenon resulting from interactions between genes of different loci. The alteration in the phenotypic expression of a gene at one locus is due to the interference of another gene at a different locus.

Epistasis could be categorized into two types; dominant epistasis and recessive epistasis, based on the nature of the gene interaction. This causes deviation from the phenotype ratios of Mendelian principles.

Dominant epistasis

When a dominant allele at a specific locus alters the expression of a separate gene at a different locus, it is referred to as **dominant epistasis**. Dominant epistasis is seen in the plumage colour of house fowls. Consider the following experiment.

A cross between a known homozygous, double dominant, white housefowl and a homozygous double recessive white house fowl results a 100% white F_1 progeny. F_2 generation produced from a cross between these F_1 individuals consists of white and coloured fowls in the ratio of 13:3.

The colour of these two fowl varieties are determined by two separate genes;

- The gene 'C'/'c' is responsible for producing colour in the feathers. The dominant 'C' allele produces colour while the recessive 'c' allele result in the absence of pigmentation.
- The gene 'I' is epistatic to gene 'C' and suppresses the expression of the colour. The dominant 'I' allele prevents production of pigments while recessive 'i' allele is unable to prevent colouration.

As a result, the double dominant homozygous (CCII) house fowl is white (dominant I allele prevents colouration). The double homozygous recessive house fowl (ccii) is white (recessive c allele couldn't produce colour).

The F_1 generation all consist of heterozygous (CcIi) fowls. Due to the inhibitory effect of the dominant 'I' allele, all F_1 individuals are white. When these fowls are allowed to interbreed, the F_2 generation genotypes carrying inhibitory 'I' allele will give rise to white colour plumage, despite the presence of the dominant 'C' allele. The presence of dominant 'C' allele in the absence of inhibitory 'I' allele gives rise to coloured fowls.

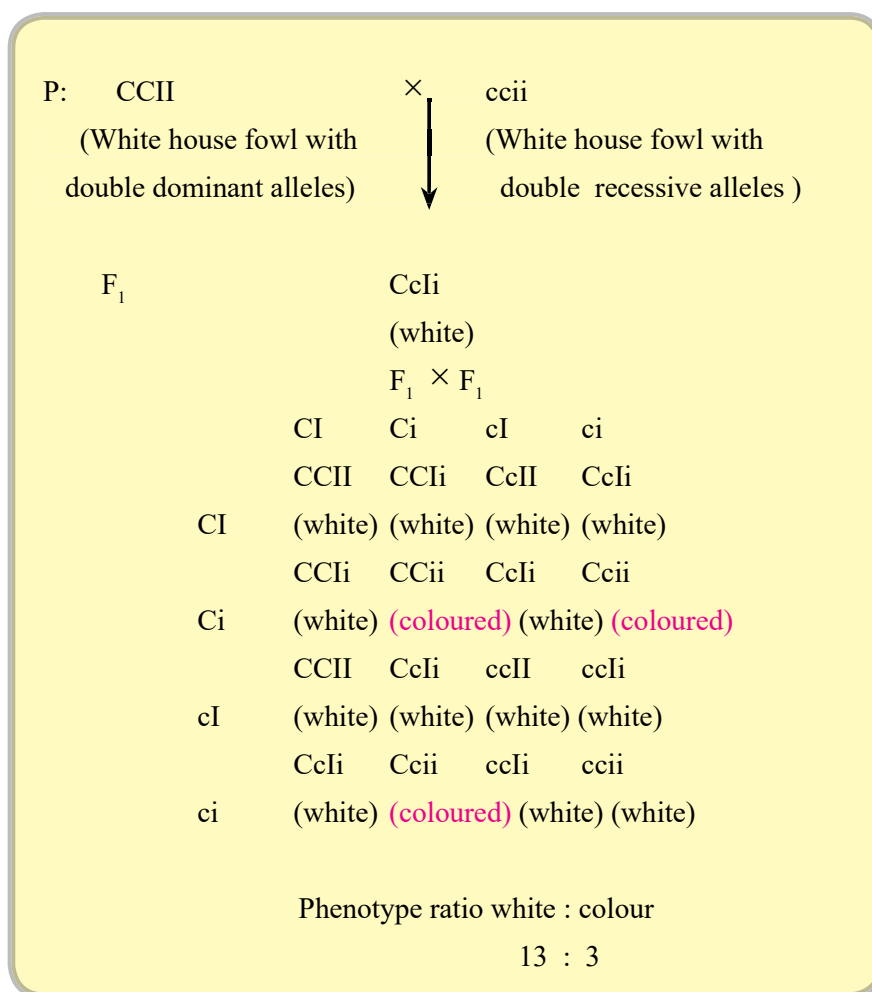

Figure 6.12: An example of dominant epistasis-Plumage colour of house fowl

As per the Mendelian principles, genotype ratios in both F₁ and F₂ generation are expected to be similar to the genotype ratios seen in a normal dihybrid cross. However, due to the effect of epistasis, phenotype ratio would deviate from Mendel's principles for normal dihybrid cross. F₂ phenotypic ratio may get altered from 9:3:3:1 to 13:3.

Recessive epistasis

When a homozygous recessive genotype of a particular chromosomal locus alters/ masks the expression of a separate gene at a different locus, it is referred to as **recessive epistasis**.

A good example for recessive epistasis is found for flower colour in sweet pea (*Lathyrus*) plant. There are purple flowered and white flowered varieties.

A cross between homozygous dominant purple flower (AABB) and homozygous recessive white flower (aabb) strains produced 100% purple colour flowers in F₁ generation. Inter breeding of F₁ plants produced F₂ generation with purple and white flower plants in a ratio of 9: 7.

The purple colour in sweet pea flower is governed by two dominant genes, A and B. Both A and B alleles are coding for compounds that are necessary for the expression of purple colour. Hence, purple colour will be there only when both the dominant alleles (A and B) are present.

Double recessive genotype at any locus (AAbb, aaBB, Aabb or aabb) results white flowers by masking the expression of purple colour. Thus, double recessive genotype at any of the above locus is epistatic to either homozygous dominant (AA and BB) or heterozygous condition (Aa and Bb) of the other. (AAbb, Aabb, aaBB, aaBb, aabb- White and AaBb, AaBB, AABb, AABB- Purple)(Figuer 6.13)

All of the F₁ generation plants were found to express purple flowers due to the presence of heterozygous condition at both loci (AaBb).

In F₂ generation, plants having genotypes with both A and B alleles (9/16) express purple flowers, and plants having genotypes with 'aa' and a 'B' allele (3/16) or 'A' allele and 'bb' alleles (3/16) and 'aabb' genotype (1/16) produce white flowers, thus only two phenotypic classes are expressed; purple and white. Thus, the normal dihybrid phenotype ratio as per Mendelian principles 9:3:3: 1 is changed to 9: 7 ratios in F₂ generation.

Parents	Purple Flower AABB	×	White Flower aabb	
		↓		
F ₁	AaBb		(Purple Flower)	
F ₁ × F ₁	F ₂			
	AB	Ab	aB	ab
AB	AABB	AABb	AaBB	AaBb
	[P]	[P]	[P]	[P]
Ab	AABb	AAbb	AaBb	Aabb
	[P]	[W]	[P]	[W]
aB	AaBB	AaBb	aaBB	aaBb
	[P]	[P]	[W]	[W]
ab	AaBb	Aabb	aaBb	aabb
	[P]	[W]	[W]	[W]
P = Purple Flower, W = White Flower				

Figure 6.13: an example of recessive epistasis - flower colour of sweet pea plants

Polygenic inheritance

Inheritance of a phenotype such as quantitative characters; height, skin colour, intelligence quotient etc. which results from a cumulative expression of two or more genes is called polygenic inheritance.

e.g. Skin colour in humans is determined by many genes. For simplicity only three genes are considered. Each gene (A, B, or C) has a dark-skin allele contributing one “unit” of darkness to the phenotype and being incompletely dominant to the other allele (a, b, or c). Therefore

AABBCC person: very dark skin

aabbcc person: very light skin

AaBbCc person: intermediate between skin colour

Because the dominant alleles from various loci have a cumulative effect, on the skin colour. (Campbell et al, 2015)

Based on the number of genes involved in determining a polygenic character, the phenotypic and genotypic combinations in the progenies may vary. Data for a polygenic character representing a population may result in a **normal distribution curve**. The majority of offspring would be expected to have intermediate phenotypes (skin colour in the middle range).

Genetic linkage

Some genes coding for particular characters are located on the same chromosome and also at a closer distance. Thus, they escape from crossing over and independent assortments occur during the meiotic cell division at gametogenesis and inherit together. This results in deviation from Mendel’s law of independent assortment. The above phenomenon is called genetic linkage.

E.g. Inheritance of body colour and wing size in the fruit fly *Drosophila*

In *Drosophila*, wild-type flies are found to have gray bodies and normal-sized wings. Due to mutation for the above traits body colour becomes black and wings become vestigial. Both characters are determined by genes of autosomal chromosomes.

In this example, the mutant alleles are recessive to the wild-type alleles. The alleles for body colour are indicated as G (gray) and g (black), and those for wing size are indicated as N (normal) and n (vestigial).

To examine the above, wild type flies were crossed with flies which are mutant to both body color as well as wing size and followed by a dihybrid test cross.

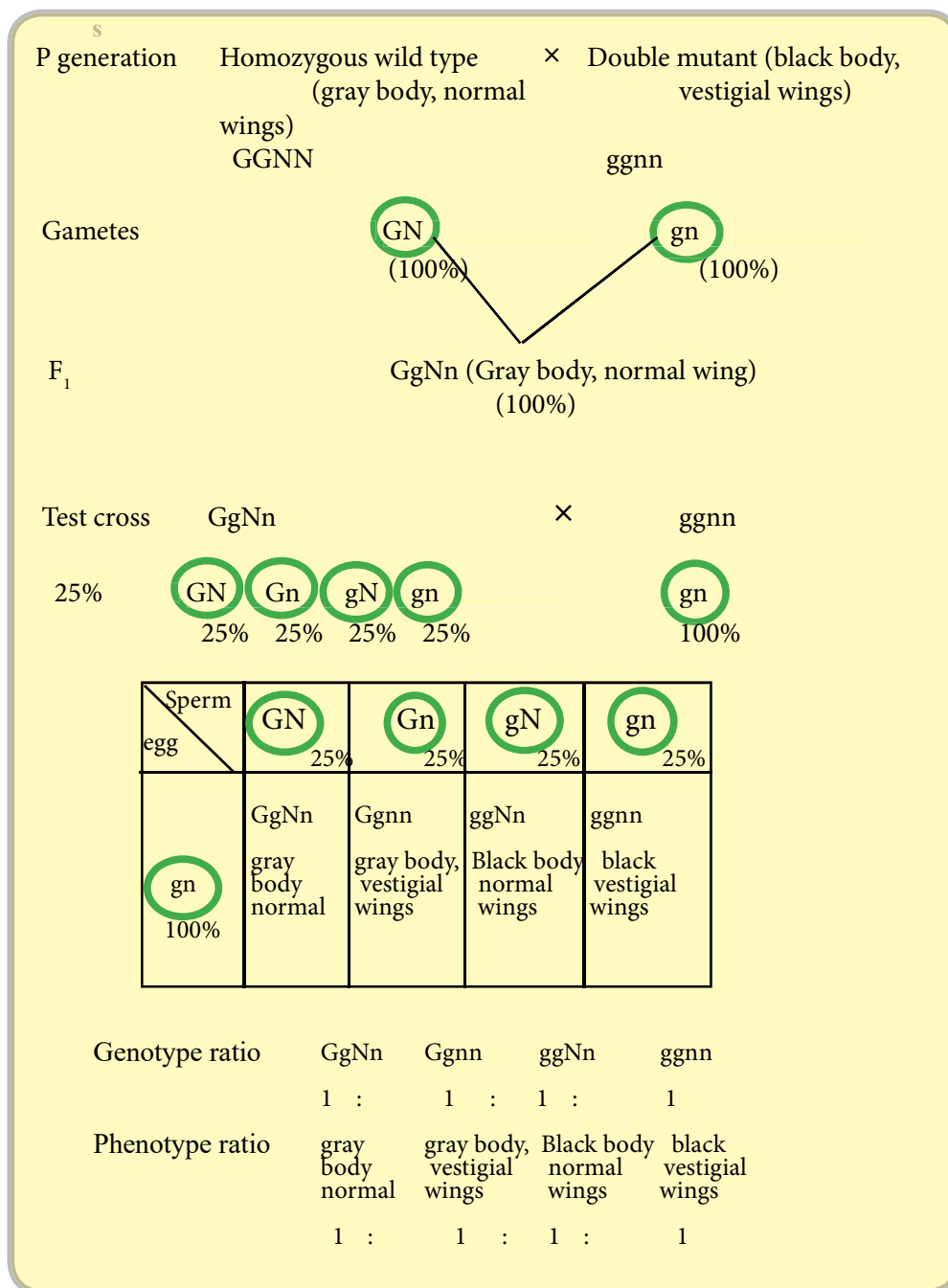

Figure 6.14: Prediction of inheritance of body colour and wing size in the fruit fly *Drosophila* as per Mendelian principles

Most offspring had a parental (P generation) genotype, indicating that the genes for body colour and wing size are genetically linked on the same chromosome.

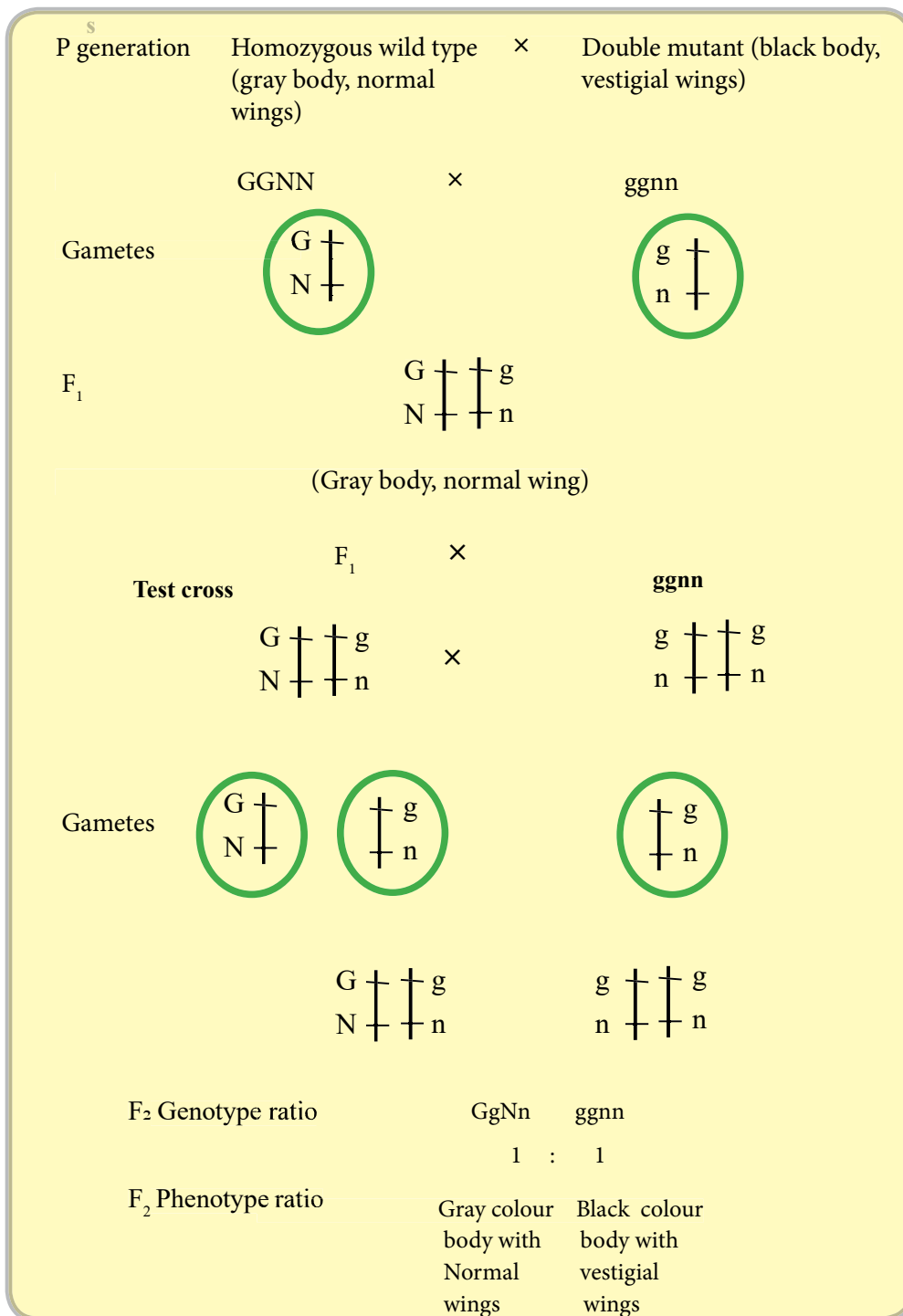

Figure 6.15: Inheritance of body colour gene and wing size gene in the fruit fly *Drosophila*

Though, the genes for body colour and wing size are linked, in some occasions, they get assorted independently due to crossing over. Therefore, the above test cross may results recombinant offsprings in lower frequency. for example, in Morgan's experiment recombinant phenotypes Gray colour body with vestigial wings (Ggnn) and Black colour body with normal wings (ggNn) were observed in lesser numbers.

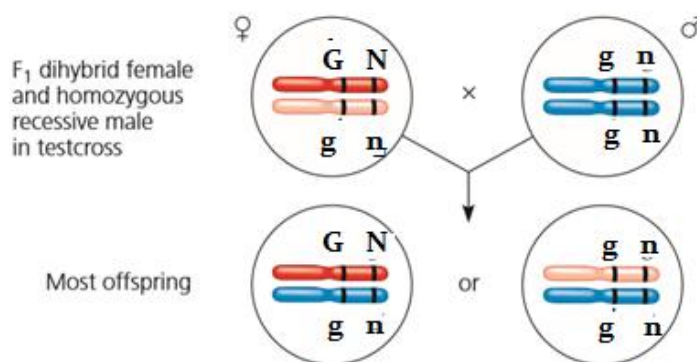

Figure 6.16: Linkage of genes responsible for body colour and wing size in the fruit fly *Drosophila*

The production of a relatively small number of offspring with non-parental phenotypes indicated occasional breaks in the genetic linkage. This is due to the crossing over occurs between the homologous chromosomes.

Human sex determination

Sex is determined by the expression of sex chromosomes. In humans, each individual carries 22 pairs of autosomal chromosomes and one pair of sex chromosomes. Type of sex chromosomes expressing male traits are named Y chromosome and the other as X chromosome. Comparatively X chromosome is bigger than Y chromosome. They both code for different traits except their homologous regions. When X and Y chromosomes pair up, they remain homologous only in specific regions. On the other hand when chromosome X, X pair up, they both remain homologous to each other.

On the occurrence of gametogenesis in females, meiosis yields haploid eggs carrying 100% X chromosomes, whereas in males, half the number of the haploid sperms produced carry X and the remaining half Y chromosomes. During the fertilization of male and female gametes, the occasion where both egg and sperm carry X chromosomes results in a female zygote, and on the other hand, an occasions where an egg fuses with a sperm carrying Y chromosome results in a male zygote.

Thus, any mating occasions between male and female organisms of same species leading to fertilization can have fifty percent chance for yielding either male or female zygotes.

Anatomical sex signs develop in humans based on the expression of XX and XY chromosomal combination.

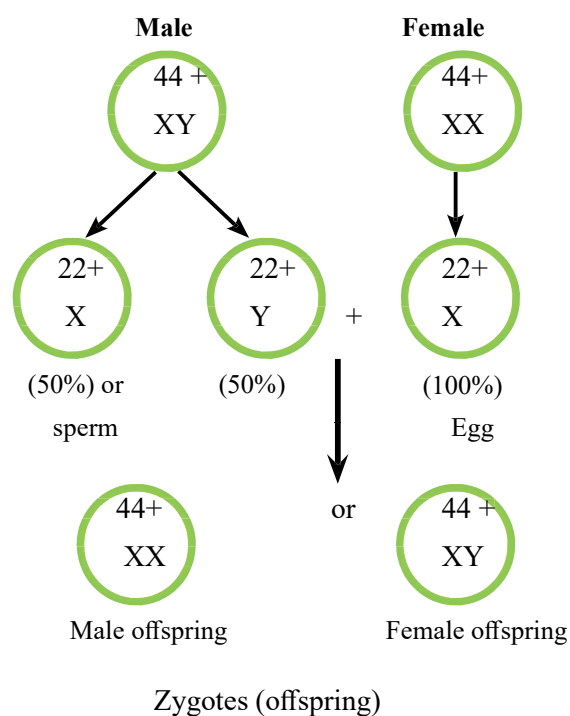

Figure 6.17: Sex determination of humans

Human sex linked characteristics

Certain characters of humans are carried on the genes located on the sex chromosomes. Those genes located on the sex chromosomes are called sex linked genes and the characters expressed by them are called sex linked characters.. Characters expressed by or carried on the X chromosome are called X- linked characters and the genes expressing or carrying those characters are called X- linked genes. On the other hand, characters which are expressed by or carried on the Y chromosome are called Y linked genes and the genes expressing or carrying those characters are called Y linked genes. Y chromosome carry only few genes other than those related to the sex. Some disorders carried on the Y-linked genes are transferred and expressed only through male progeny.

e.g. absence of certain Y-linked genes causes inability to produce normal sperm.

In addition to sex related characters, X chromosomes carry many other characters which are not relevant to individual sex.

e.g.

Red green colour blindness: *An X-linked recessive disorder characterized by the difficulty in perceiving differences between red and green colours.*

Haemophilia: An X-linked recessive disorder where one or more of the proteins required for blood clotting are absent. Haemophilic person run the risk of severe bleeding during injuries due to the delay in clot formation. (Campbell et al, 2015)

Inheritance of X-linked genes

The inheritance of sex linked characters or genes differ for male and female due to the XX genotype of female and the XY genotype of male. During the fertilization, X chromosome from both of their biological parents result a female zygote and on the other hand, X chromosome from the female parent and Y chromosome from the male parent results a male zygote. Thus, for females, X-linked recessive disorders are expressed only at their homozygous genotype. However in males, due to the presence of only one X chromosome, have only one recessive X-linked allele. Therefore, having a recessive X-linked allele with disorder is sufficient for expression.

Pleiotropy

In some occasions, expression of a single gene affects the expression of multiple traits which are not related to each other. The above phenomenon is called as Pleiotropy. Pleiotropic alleles are responsible for the multiple symptoms associated with certain hereditary diseases in humans, such as cystic fibrosis and sickle-cell disease.

Sickle-cell disease

Sickle cell disease is caused by an alteration in the haemoglobin protein of red blood cells. A single gene mutation is responsible for the above condition. In homozygous recessive individuals, all the haemoglobins are of the sickle-cell variety. People living in high altitudes or under physical stress experience low oxygen content in their blood. Low oxygen content in the blood may induce the sickle-cell haemoglobin proteins to get accumulated and results sickle shape in red blood cells. Sickle cells may clump and clog small blood vessels causing tissue and organ damage in several body parts. This may result renal failure, heart failure and thrombosis.

Cystic fibrosis

Cystic fibrosis is a disease condition causing thicker and stickier mucus than its normal nature. As a result, mucus get accumulated in the pancreas, lungs, digestive tract, and reproductive organs which cause lung infections, respiratory failure, poor digestion, and infertility.

The thickening of mucus is due to the excess chlorine secretion of defected chloride channels of the plasma membrane. The defect in the trans-membrane chloride channel occurs as a result of the Cystic Fibrosis Trans-membrane Regulator (CFTR) protein. The altered CFTR protein is due to the mutation of CFTR gene. This is identified as autosomal recessive disorder.

Epigenetics

Study of occurrence of certain phenotypes of certain characters controlled by factors other than their DNA sequence or genetic code is called epigenetics. This is due to ‘switching on’ and ‘switching off’ of certain genes by modifying nucleotides of a DNA sequence by methylation and demethylation, where methyl groups are added to wild type DNA sequence or else removed from a methylated DNA sequence. The above random occasions result different modified expression for a single DNA sequence.

Epigenetics results due to either inherited signals from parents or signals arising due to the environmental factors. Inheriting epigenetic traits from parents to the children's generation is called epigenetic inheritance. This may get reversed by various external stimuli from the environment. Some epigenetic influences result in inappropriate gene expressions leading to cancers.

Schizophrenia is a mental disorder that occurs due to the genetic defects. In some identical twins, only one of them gets schizophrenia and the other does not get it. This is due to two types of expressions for same DNA sequence, called epigenetics.

Population genetics

Hardy-Weinberg Equilibrium

Hardy-Weinberg Equilibrium is used to assess whether a population is evolving with respect to a particular characteristic/ genetic locus. The genetic makeup of a trait in a population would remain unchanged, if they are not evolving at that genetic locus. Therefore, the predicted data for a particular trait of a population can be compared with the actual data obtained from the same population. The comparison of both data as mentioned above may help to determine whether the population evolves or not for the considered trait.

Hardy-Weinberg Equilibrium Principle

In 1908 British mathematician **G.H. Hardy** and German physician **W. Weinberg**, independently showed that, in a population that is not evolving, allele and genotype frequencies will remain constant from generation to generation. This is now considered as key concept in population genetics and referred to as **Hardy-Weinberg Equilibrium Principle**.

To determine whether the allele and genotype frequencies have changed in consecutive generations, a Punnett square can be drawn, considering the combination of alleles in all possible crosses in a population.

The following example can be used to work out the Hardy Weinberg equilibrium.

A wild flower plant population showing incomplete dominance for the flower colour alleles have distinct phenotypes indicating their genotypes. i.e.

Plants homozygous for the C^R allele ($C^R C^R$) produce red pigment and have red flowers. Plants homozygous for the C^W allele ($C^W C^W$) have white flowers .

Heterozygous plants ($C^R C^W$) produce some red pigment and have pink flowers.

In the population of 500 flowers, there were 800 C^R alleles and 200 C^W alleles. Since the flower colour of the above plant type is determined by pair of alleles, 500 flowers may consist of 1000 alleles for their flower petal's pigmentation.

Therefore,

- allele frequency of C^R alleles (p) = $\frac{800}{1000} = 0.8$
- allele frequency of C^W alleles (q) = $\frac{200}{1000} = 0.2$

If the gametes are formed at random, the probability that an egg or sperm contains a C^R or C^W allele is equal to the frequency of each of these alleles in the population. Thus, each egg has an 80% chance of containing a C^R allele and a 20% chance of containing a C^W allele; the same is true for each sperm.

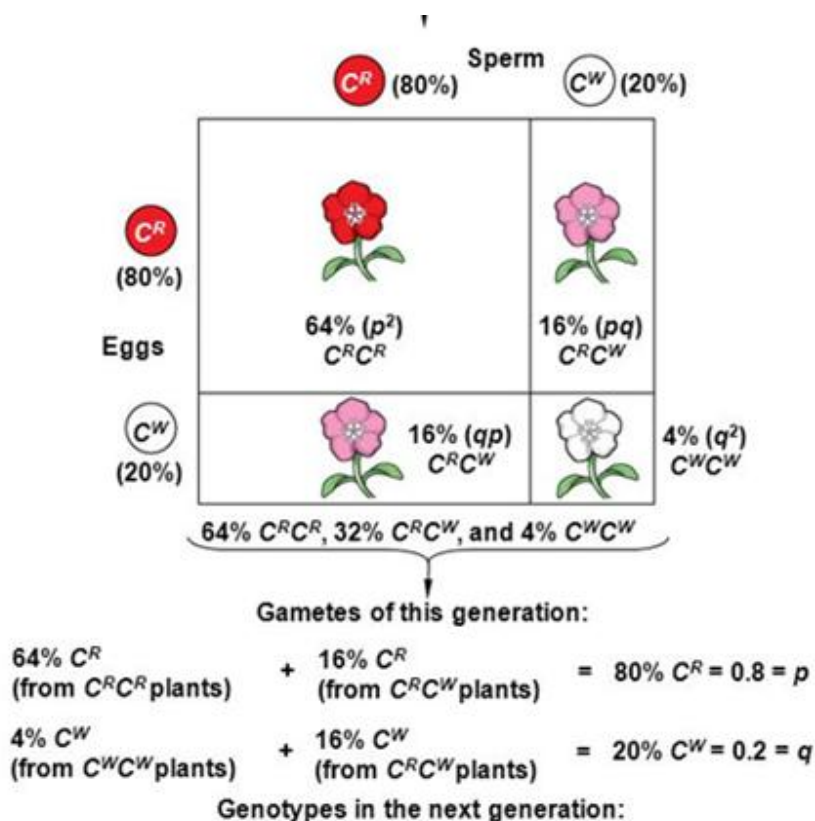

Figure 6.18: The Hardy-Weinberg Principle (Campbell et al, 2015)

During random fertilization, gametes fuse together randomly. Therefore, rule of multiplication can be applied to calculate the probability for each genotype combination.

According to Hardy-Weinberg equilibrium, if a character is determined by two alleles, the three genotypes will appear in the following proportions;

P_2 = frequency of dominant homozygotes

q_2 = frequency of the recessive homozygotes

$2pq$ = frequency of the heterozygotes

The probability that two C^R alleles will come together, $p \times p = p^2 = 0.8 \times 0.8 = 0.64$

Hence the proportion of $C^R C^R$ genotype in the progeny = 64%

The probability that two C^W alleles will come together, $q \times q = q^2 = 0.2 \times 0.2 = 0.04$

Hence the proportion of $C^W C^W$ genotype in the progeny = 4%.

$C^R C^W$ heterozygotes can arise in two different ways.

If the sperm provides the C^R allele and the egg provides the C^W allele,

the resulting $C^R C^W$ heterozygotes in the progeny, $p \times q = 0.8 \times 0.2 = 0.16 = 16\%$

If the egg provides the C^W allele and the sperm the C^R allele,

the resulting $C^R C^W$ heterozygotes in the progeny, $q \times p = 0.2 \times 0.8 = 0.16 = 16\%$

Thus, the total frequency of heterozygote in the progeny

$$pq + qp = 2pq = 0.16 + 0.16 = 0.32, \text{ or } 32\%$$

In the above example, only three kinds of genotypes are possible. When conditions suits for Hardy-Weinberg equilibrium, the sum of frequencies of all three genotypes equals 1. Thus, the equation for Hardy-Weinberg equilibrium can be written as below;

$$P^2 + 2pq + q^2 = 1$$

Conditions for Hardy-Weinberg Equilibrium

The Hardy-Weinberg approach describes a hypothetical population that is not evolving and fulfilling the following conditions.

1. **Absence of mutations.** Mutations result changes in alleles. Insertion, deletion, or substitution of nucleotides result altered alleles. This leads to modified gene pool.
2. **Occurrence of random mating.** Breeding occurs randomly without any influence that causes selectiveness. Mating of closely related individuals may alter the allele frequencies.
3. **Absence of natural selection.** All genotypes of the progeny are expected to survive irrespective to their differences, abilities and the environmental conditions. Variations in survival and reproduction of some genotypes may alter the frequency of alleles.
4. **Size of the population is extremely large.** In small populations, particular genotypes may disappear due to death or infertility. Therefore, larger the population, more likely to favor the Hardy-Weinberg equilibrium.

5. **Absence of immigration or emigration.** Individuals moving in and out of the populations may cause appearance of new genes and disappearance of existing genes. This is called gene flow and it may alter allele frequencies.

Naturally, most populations do deviate from Hardy-Weinberg equilibrium except for certain genetic loci. Slowly evolving populations may also do not deviate much from Hardy-Weinberg equilibrium and therefore, they remain as predicted for a non-evolving population.

Evolution and change in gene frequency

Evolution can be explained in terms of changes in allele (gene) frequencies over generations. A species evolves when changes in gene frequencies drive the species into a higher level of adaptation for a specific ecological niche.

Genetic variation within the population is the key to evolution. Mutation will create new alleles and migration will include it into the population to increase variation. Natural **selection will then choose the better adapted individuals based on their phenotypic variations, causing population to evolve.** As a result, after the evolution the population is at a higher adaptive level compared to the level of adaptation they showed before being evolved.

This concept can be illustrated with the evolution of the peppered moth in England during the time of industrialization. The moth had two phenotypic varieties based on their colour; dark and light. Prior to the industrialization of central England, the light-coloured allele was most prevalent. The light-coloured moths had an advantage over the dark coloured ones as they could hide on the white-barked trees to avoid predation from birds.

Due to the pollutants generated parallel to the industrialization, the light-coloured trees were stained dark. This exposed the light- coloured moths to predation, reducing their numbers. As a result, the light- colour allele became less prevalent. In its place, the dark-colour allele became more predominant, because dark moths could camouflage themselves better on the stained trees and avoid being eaten by their bird predators. The population evolved to a higher adaptive state with the change in gene frequencies (light – colour allele frequency went down while dark – colour allele frequency went up).

Plant and animal breeding

People have intervened in the reproduction and genetic make up of plants and animals since the dawn of agriculture, eight to ten thousand years ago. Early farmers selected the best looking plants and seeds and saved them to plant for the next season. Likewise, the best farm animals were allowed to mate with each other to preserve and improve their desirable traits.

This phenomenon wherein human beings interfere in the process of reproduction to allow only selective mating to occur, so that offspring with improved characters are produced is called **breeding** (as against natural reproduction).

With the science of genetics became better understood, plant and animal breeders used what they knew about the genes of a plant or an animal to select for specific desirable traits to develop improved plant varieties or animal breeds. The selection for features such as faster growth, higher yields, pest and disease resistance, larger seeds or sweeter fruits in crop plants, colour and pattern of the skin, hair or feathers in animals have now dramatically changed domesticated species compared to their wild relatives.

Importance of plant and animal breeding

In breeding programmes, the attributes, structure and composition of plant and animals are manipulated in such a way to make them more useful to humans. Accordingly, plant and animal breeding has a significant impact of world's agro-economy as discussed below;

Addressing world food and feed quality needs

An estimated 800 million people in the world, including 200 million children, suffer from malnutrition and associated health issues. Plant and animal breeding helps to enhance the value of food by improving their nutritional quality. For example, rice, which is the most widely eaten staple food, lacks many essential vitamins.

Another problem encountered in major food crops is the presence of toxic substances within them such as alkaloids in yam, cynogenic glucosides in cassava (manioc), trypsin inhibitors in pulses, and steroidal alkaloids in potatoes. Plant breeding is useful in reducing these toxic components and making them safer to eat. Plant breeding is also useful in making some plant products more digestible. For example, a high lignin content of the plant material reduces its value for animal feed which can be overcome with the use of breeding techniques.

Addressing food supply needs for a growing world population

It is anticipated that an additional three billion people will be added to the world population within the next three decades. Aligned with this population growth, an expansion in world food supply should be required to meet the projected needs. Unfortunately, land for farming is scarce and therefore more food will have to be produced on less land. This calls for improved and high yielding animal and plant varieties to be developed. In response plant breeding has produced super rice which has 50% more yield compared to the normal rice, super wheat which boost the

harvest by 20-40% of normal wheat and several high yielding corn, maize and soya bean varieties. The total production of meat and milk has also increased considerably over the years due to careful use of selective breeding techniques.

Need to adapt to environmental stresses

Weather and soil conditions can have a major impact crop yield. Climate changes and global warming are partly responsible for modifying the crop production environment (e.g., some regions of the world are getting drier and others saltier). To meet the increasing demand for food new cultivars need to be bred which can sustain these adverse conditions. For example, it is necessary to develop new plant types that can resist various biotic (diseases and insect pests) and other abiotic (e.g., salt, drought, heat, cold) stresses in the production environment. In response, genetically modified, pest resistant cotton, maize, and potatoes which carry Bt toxin, salinity tolerant rice varieties, cold tolerant tobacco, potato and strawberry varieties etc. are now available in agricultural industry. Likewise, both crop plants and farm animals (cattle, pig sheep goat etc.) with increased immunity to pathogens have also been produced through various breeding techniques.

Satisfying industrial and other end-use requirements

Consumers are having different requirements based on the texture, colour and composition of a particular food item irrespective of its taste or nutritional value. These diverse demands for the same food can be now successfully met through breeding procedures. For example, potato is a versatile crop used for food and industrial products. Different varieties are being developed by breeders for baking, cooking, fries (frozen), chipping, and for starch. These cultivars differ in size, specific gravity, and sugar content, among other properties. High sugar content is undesirable for frying or chipping because the sugar caramelizes under high heat to produce undesirable browning of fries and chips. Likewise, there is a high demand for seedless fruits such as grapes, melon and strawberries and also for leaner meat. Depending on these end-user requirements, it is possible to develop quality added products using animal and plant breeding techniques.

Developing animal and plant varieties with aesthetic values

Aesthetics is of major importance in horticulture as well as in the industry of ornamental and pet animals. The ornamental plant industry depends to a large extent on the development of new varieties that exhibit new flower/ leaf colours, varying sizes and attractive shapes etc. using plant breeding.

The pursuit of novelty has spurred a similar explosion of types in pet animals as well. Today selective breeding for numerous morphological features and functional abilities have given rise to nearly 400 dog breeds making them one of the most diversified species on earth. Likewise, there

are close to 50 rabbit breeds, vast number of bird varieties and an extensive range of ornamental fish.

Breeding techniques

Plant and animal breeders use numerous techniques to create new varieties with enhanced features. Many of these techniques have been successfully practiced over centuries even without the knowledge of the underlying genetics. Following section summarizes some of these traditional breeding techniques which has caused significant improvements in agriculture and farming.

Artificial selection

Artificial selection is the earliest form of biotechnology and has been used by humans for thousands of years. It, is a process of selective breeding, where plants or animals with specific traits were selected to breed so that their desired traits could be passed to the next generations to produce a high performing new variety. The method has made a huge impact on agriculture by way of improving plant and animal products before the discovery of more sophisticated technologies like genetic engineering.

The first prerequisite of artificial selection is the availability of variation with respect to the desirable characters. Once a population with a desirable variation is recognized, the best performing individuals for the desired feature are selected. For example, when selecting for fruit size in plants, only those giving the biggest fruits are chosen for the breeding programme and the rest of the population is discarded or rejected. The progeny of the selected individuals is grown further and again screened for the desired feature. This process is repeated sometimes for many generations, until a uniform plant population is attained which has the best-desired characters. Eventually, a new uniform crop variety with the desired characteristic is produced by this successive selection, followed by multiplication of the selected individuals.

The advantage of selective breeding is that it uses the processes of natural selection, but under direct supervision from carefully selected animals or plants with the desired traits. There are no genetic modifications or other forms of tampering that could potentially harm people and the risk to the plant or animal is often minimum.

Crops like corn and wheat are commonly selectively bred in order to obtain the highest yielding plants. Breeding animals with higher protein and lower fat percentages, as well as plants that have higher nutritional values, had been used to create food sources with a higher quality of nutrition. In addition, selective breeding has, effectively removed undesirable traits such as low resistance to disease, in some animals and plants.

However, selective breeding among animals can take a long time for the process to work. In horse breeding, for example, the given standard to establish a new breed is to have offspring with the desired traits to be produced over the course of 7 generations. This means it may take 25-50 years for the desired traits to become a foundational component of an animal.

Inbreeding and out breeding

Inbreeding

The breeding among genetically similar individuals are known as inbreeding.

Among plant breeders the term “inbreeding” is commonly used to mean self-fertilization, i.e. the fertilization of a flower with its own pollen or with pollen from a different flower on the same plant. This is done to produce an inbred variety, which is exactly the same generation after generation. Many important crops, such as wheat, oats, barley, and tobacco, are produced from seeds which are habitually self-fertilized.

However, in animal breeding the term " inbreeding " is used to refer to the mating of closely related individuals, as, for instance, the mating of father and daughter, brother and sister, or cousins. In both crop plants and farm animals, inbreeding brings uniformity of the required type while preserving the desired characters. Inbreeding is used for developing pure lines in agriculture as well as for research.

As a rule, inbreeding increases homozygosis and thus exposes harmful recessive genes which would have otherwise stay hidden among heterozygotes. Continued inbreeding, therefore, reduces genetic fitness of the population. As a result, the growth and fertility of the inbred population would go down with adverse effect on their productivity. Prevalence of genetic disorders might also increase among the inbred population. This phenomenon of having a reduced genetic fitness in a given population as a result of inbreeding is called **inbreeding depression**.

However, in agriculture and animal husbandry, positive effects of inbreeding will be harnessed as much as possible. To ensure this, only those offspring that are exhibiting the desired trait, without other negative ones, will be used for future breeding. The negatively affected individuals in the progeny are removed or are not be allowed to be bred. Thus, inbreeding is used in agriculture to help accumulation of superior genes.

Outbreeding

When plants or animals of different breeds (races) are mated with each other, it is known as **outbreeding** or **cross breeding**. This allows the desirable characters of the exotic parent, which the indigenous parent does not have, to be transmitted to the progeny.

For example, cross breeding is carried out by animal breeders to enhance milk and meat production. In India zebu breeds of cows and nondescript cows are crossed with exotic breeds like Holstein Friesian, Brown Swiss and Jersey bulls or their semen, to enhance the milk production potential of the progeny. Likewise crop plants like corn and hemp, are normally cross-fertilized.

Hybrid breeding

When genetically unrelated pure-bred plants or animals in the same species are mated with each other it is known as **hybridization** or **outcrossing**.

Generally, this is carried out with plants and animals who do not share common ancestors on either side of their pedigree up to four to six generations. The offspring of such a mating is known as the **out cross** and will possess stable characteristics and hybrid vigour. **Hybrid vigour**, also called **heterosis**, is the increase in such characteristics as size, growth rate, fertility, and yield in the hybrid organism over those of its parents.

Plant and animal breeders exploit heterosis by mating two different pure-bred lines that have certain desirable traits. The first-generation offspring generally show, in greater measure, the desired characteristics of both parents. This vigour may decrease, however, if the hybrids are mated together; so the parental lines must be maintained and crossed for each new crop or group desired.

In plant breeding, because creating hybrids involves many years of preparation to create pure lines that have to be constantly maintained so that F_1 hybrid seeds can be harvested each year, the seeds then become more expensive. Nevertheless, hybrid seeds have had a tremendous impact on agricultural productivity. Today, nearly all corn and 50% of all rice are hybrids. In the US, the widespread use of corn hybrids, coupled with improved cultural practices by farmers, has more than tripled corn grain yields over the past 50 years from an average of 35 bushels per acre in the 1930s to 115 bushels per acre in the 1990s. No other major crop anywhere in the world even comes close to equaling that sort of success story.

Many cultivars of popular vegetables or ornamental plants are hybrids. In terms of improved plant characteristics, tropical vegetable breeders can point to some rather clear achievements over the last two decades:

- **Yield improvement.** Hybrids often out yield traditional true breeding varieties (inbred varieties) by 50-100% due to its improved vigor, improved genetic disease resistance, improved fruit setting under stress, and higher female/male flower ratios.
- **Extended growing season.** Hybrids often mature up to 15 days earlier than local true breeding varieties. For many crops, the hybrid's relative advantage over the true breeding is most pronounced under stress conditions.
- **Quality improvement.** Hybrids have helped stabilize product quality at a higher, and more uniform level – this implies improved consumption quality (e.g. firm flesh of wax gourd, crispy taste of watermelon).

Interspecific breeding

In this approach, which is also known as interspecific hybridization, male and female organisms of two different species are mated. The progeny obtained from such a mating are usually different from both the parental species and may be fertile, partially fertile, or sterile.

Plants hybridize much more frequently and successfully than animals do. Pollen from flowering plants disperses widely and may land on flowers of other species allowing natural interspecific breeding to take place. Plant forms are less stringently controlled than animal forms, and so the intermediate form of a plant hybrid is more likely to be physiologically successful.

Often interspecific hybrids are sterile or for some other reason cannot interbreed with the parental species. Occasionally sterile interspecific hybrids can undergo a doubling of their chromosome set and become fertile tetraploids (four sets of chromosomes). For example, the bread wheats that humans use today are a result of two hybridizations each followed by chromosome doubling to produce fertile hexaploids (six sets of chromosomes). In such instances, the hybrids can become new species with characteristics different from either of the parents. Crop yields increase dramatically when hybridization is used to exceed one or more of the parents in size and reproductive potential. For example, boysenberries (*Rubus ursinus* x *idaeus*) were developed at Knott's Berry Farm in California. They are a result of a set of crosses between blackberries (*Rubus fruticosus*), European raspberries (*Rubus idaeus*) and loganberries (*Rubus* × *loganobaccus*).

For many fruit crop species, the use of interspecific breeding is increasing, in order to utilize naturally occurring sources of pest and disease resistance, fruit-quality components, etc. within the available germ plasm. For example, winter hardiness of apple was improved by making a hybrid species *Malus* × *domestica* from *Malus* × *asiatica* and *Malus pumifolia*.

However, among animals interspecific breeding is restricted to few species. Common examples include Mule (male donkey x female horse), Hinny (male horse x female donkey) and Liger (male lion x female tiger).

Note that in mules and hinnies, the common genus the parents belong to is *Equus* and in liger, its *Panthera*. Other examples are zebra/donkey cross resulting in an offspring called zonkey, zebra/horse cross resulting in zorse. The offspring from this cross could develop into adults, but may not develop functional gametes. Sterility is often attributed to the different number of chromosomes the two species have, for example, donkeys have 62 chromosomes, horses have 64 chromosomes.

Genetic principles of breeding techniques

From the beginning of plant and animal breeding, farmers made use of principles of genetics, with or without awareness of these concepts. Following section explains, three most widely used genetic principles applied in animal and plant breeding at present.

Polyploidy

Polyploidy refers to the presence of more than two complete sets of homologous chromosomes per cell nucleus. This is a widely used principle in plant breeding. In plants, polyploidy can be induced artificially using antimetabolic agent, colchicine.

One of the most important consequences of polyploidy for plant breeding are the increment in plant organs (“gigas” effect) caused by the larger number of gene copies. Polyploid individuals may thus exhibit larger organs compared to their diploid counterparts, such as roots, leaves, tubercles, fruits, flowers and seeds. Polyploid plants also have lower growth rates, and tend to flower later or over a longer period of time than related diploids, which is a desirable feature for ornamental breeding.

In addition, polyploidy often results in reduced fertility due to meiotic errors, allowing the production of seedless varieties such as the triploid watermelon. On the other hand, when the crossing between two species is not possible because of differences in ploidy level, polyploids can be used as a bridge for gene transferring between them. Similarly, the genome doubling in a newly formed sterile hybrid allows the restoration of its fertility.

Genome redundancy (having additional gene copies due to increase ploidy) have other benefits as well. It promotes a “buffering” effect in which the deleterious alleles are masked by the extra copies of wild-type alleles. At the same time, it allows functional diversification of redundant gene copies, in which one member of a duplicated gene pair mutates and acquires a novel function, without compromising essential functions.

The increment in heterozygosity is another feature that accompanies polyploidy. Higher levels of heterozygosity have been positively related to vigor increment in maize, potato and alfalfa improving the product quality and increasing the tolerance to both biotic and abiotic stresses.

Mutation Breeding

Methods for inducing mutation have the potential of producing new sources of genetic variability for crop breeding. These methods can be employed when it appears there is little, or no, variability for the character to be improved available within the gene pool of the species. This method of inducing desirable mutations in crop plants using either chemical or physical agents was termed **mutation breeding**.

Several agents can be used to cause mutations. This include ionizing radiation such as gamma rays, protons, neutrons, alpha and beta particles and chemicals such as sodium azide and ethyl methanesulphonate. Since the desirable mutations induced by these treatments are found at a very low frequency (0.1% of total mutations), breeders have to screen a large population to select a desirable mutation. In addition, most mutations act in a recessive fashion and are likely to be masked by their dominant allelic counterparts making the screening procedure even harder.

The effectiveness of using induced mutation depends on the breeding system of the plant. Its use in self-pollinated plants is likely to be more successful than in crosspollinated ones. Populations of cross-pollinated plants usually possess stores of genetic variability in the recessive condition and it would not be likely that induced mutation would produce significant amounts of new variability. Further, induced mutation is potentially useful in the improvement of asexually propagated crop plants.

Despite these limitations, mutation breeding efforts continue around the world today. It has improved both morphological and physiological characteristic of both crop and ornamental plants such as flower colours, seed size, crop yield, disease resistance and salinity tolerance, drought tolerance and early maturity. Examples of plants that have been produced via mutation breeding include wheat, barley, rice, potatoes, soybeans, and onions.

Genetic modification

Genetic modification, also called **genetic engineering**, is the direct manipulation of an organism's genes to change the genetic makeup of cells. In this method, genetic material is obtained from one organism showing a desired trait and will be inserted to another second organism using recombinant DNA technology, so that the receiving organism will also show the same desirable trait. Thus, by transferring genes within and across species, improved or novel organisms are produced.

In traditional plant breeding techniques transfer of genes is limited to the closely related species or genera. For example, traditional breeding techniques could not be used to insert a desired gene from daffodil into rice because the many intermediate species between rice and daffodil and their common ancestor is extinct. With genetic engineering, however, such gene transfers can be done more quickly, more specifically, and without the need for intermediate species. The term **transgenic** or **genetically modified organism (GMO)** is used to describe organisms that have been engineered to express a gene from another species. Advocates for plant biotechnology believe that the genetic engineering of crop plants is the key to overcoming some of the most pressing problems of the 21st century, including world hunger and fossil fuel dependency. Examples of transgenic plant varieties include transgenic papaya that is resistant to ring spot virus, “golden rice,” with increased levels of beta-carotene and salinity resistant rice varieties among others.

Natural or artificial breeding: Advantages and disadvantages

Although artificial breeding is extensively practiced today with remarkable economic gains, there are several drawbacks in the method in comparison to the natural breeding.

The artificial breeding is geared towards producing a uniform set of plants or animals with traits desirable to humans. The development of this uniformity needs compromising the variability within the species. This reduction of genetic diversity will have adverse consequences on the evolutionary fitness of the species leading to low resistance to infections, higher prevalence of congenital anomalies and reduced fertility. For example, when a population of animals or plants with the same genetic traits are attacked by a pathogen to which they are susceptible, the entire population is likely to suffer due to the absence of the resistant trait within the gene pool. This limited opportunity for the natural selection to act upon the population is likely to drive them towards a lower fitness plateau.

On the other hand, natural breeding can rule out weaknesses and disabilities which affect survival by allowing natural selection to act upon the species. This will produce fitter and stronger individuals in the long run. However, the natural selection would not guarantee a productivity increase in the consumer perspective, despite the increase in genetic fitness.

As discussed earlier, sometimes inbreeding is practiced as an artificial breeding technique. This would result in an increase in homozygosity which would in turn increase the expression of recessive deleterious mutations that would otherwise stay masked within heterozygotes. This can cause the population to undergo inbreeding depression with adverse effects on the overall fitness.

Sometimes artificial breeding can exhibit negative correlated responses. This refers to the fact that while artificial breeding is improving certain characters in the population, simultaneously and unintendedly it could lead towards deterioration of other characters that are not under direct

observation. For example, the shape of the skull in some dog breeds has made it difficult for them to eat normal food because of the upper jaw being much shorter than the lower jaw, such as in the case of Boxer or the Bulldog. Likewise, selection for large offspring has resulted in a high fraction of difficult births, sometimes requiring caesarean sections in the Texel sheep, and even almost as a standard way of delivering in the beef cattle breeds Belgian White-and-Blue cattle and the Dutch Improved Red-and-White. This kind of negative responses are difficult to predict in advance and usually only visible after the new breed is established.

Although there are negative impacts artificial breeding is still preferred over natural breeding for the numerous advantages it could bestow upon overall animal and plant productivity as discussed earlier.

Notes:

This is to acknowledge that some of the diagrams used in this book have been taken from various electronic sources using internet . This book is not published to make profit and sold only to cover cost.

The resource book is prepared according to the subject content and learning outcomes of the G.C.E. (A.L) Biology new syllabus which is implemented from 2017.

The content of this Resource book declares the limitation of the G.C.E. (A.L) Biology new syllabus which is implemented from 2017.

References

Campbell, N. A., Reece, J. B., Urry, L. A., Cain, M. L., Wasserman, S. A., Minorsky, P. V., & Jackson, R. B. (2015). *Campbell biology*. Pearson Higher Ed.

Waugh, A., & Grant, A. (2014). *Ross and Wilson Anatomy and physiology in health and illness*. Elsevier Health Sciences.